



**HAL**  
open science

# Partitions of planar (oriented) graphs into a connected acyclic and an independent set

Stijn Cambie, François Dross, Kolja Knauer, Hoang La, Petru Valicov

► **To cite this version:**

Stijn Cambie, François Dross, Kolja Knauer, Hoang La, Petru Valicov. Partitions of planar (oriented) graphs into a connected acyclic and an independent set. 2024. hal-04840861

**HAL Id: hal-04840861**

**<https://u-bordeaux-montaigne.hal.science/hal-04840861v1>**

Preprint submitted on 16 Dec 2024

**HAL** is a multi-disciplinary open access archive for the deposit and dissemination of scientific research documents, whether they are published or not. The documents may come from teaching and research institutions in France or abroad, or from public or private research centers.

L'archive ouverte pluridisciplinaire **HAL**, est destinée au dépôt et à la diffusion de documents scientifiques de niveau recherche, publiés ou non, émanant des établissements d'enseignement et de recherche français ou étrangers, des laboratoires publics ou privés.

# Partitions of planar (oriented) graphs into a connected acyclic and an independent set

Stijn Cambie<sup>1</sup>, François Dross<sup>2</sup>, Kolja Knauer<sup>3</sup>, Hoang La<sup>4</sup>, and Petru Valicov<sup>5</sup>

<sup>1</sup>Department of Computer Science, KU Leuven Campus Kulak-Kortrijk, 8500 Kortrijk, Belgium.

<sup>2</sup>LaBRI, CNRS, Université de Bordeaux, Bordeaux, France.

<sup>3</sup>School of Mathematical Sciences, Hebei Key Laboratory of Computational Mathematics and Applications, Hebei Normal University, Shijiazhuang 050024, P. R. China and Departament de Matemàtiques i Informàtica, Universitat de Barcelona (UB), Barcelona, Spain.

<sup>4</sup>LISN, Université Paris-Saclay, CNRS, Gif-sur-Yvette, France.

<sup>5</sup>LIRMM, Université de Montpellier, CNRS, Montpellier, France.

December 16, 2024

## Abstract

A question at the intersection of Barnette’s Hamiltonicity and Neumann-Lara’s dicoloring conjecture is: *Can every Eulerian oriented planar graph be vertex-partitioned into two acyclic sets?* A CAI-partition of an undirected/oriented graph is a partition into a tree/connected acyclic subgraph and an independent set. Consider any plane Eulerian oriented triangulation together with its unique tripartition, i.e. partition into three independent sets. If two of these three sets induce a subgraph  $G$  that has a CAI-partition, then the above question has a positive answer. We show that if  $G$  is subcubic, then it has a CAI-partition, i.e. oriented planar bipartite subcubic 2-vertex-connected graphs admit CAI-partitions. We also show that series-parallel 2-vertex-connected graphs admit CAI-partitions. Finally, we present a Eulerian oriented triangulation such that no two sets of its tripartition induce a graph with a CAI-partition. This generalizes a result of Alt, Payne, Schmidt, and Wood to the oriented setting.

*“A problem worthy of attack, proves its worth by fighting back!” (P. Erdős)*

## 1 Introduction

A famous and widely open conjecture of Barnette says:

**Conjecture 1** (Barnette’s Hamiltonicity Conjecture, 1969 [3]). Every 3-connected cubic planar bipartite graph is Hamiltonian.

Bipartiteness is important here, because if it is dropped, then the statement corresponds to Tait’s Conjecture [33], disproved by Tutte [35]. On the other hand, planarity is also essential, as shown by Horton [18] who disproved a corresponding conjecture of Tutte [36].

Many partial and related results are available [1, 2, 5, 7, 10–15, 19, 25]. In particular, Conjecture 1 holds on graphs on up to 90 vertices [6, 17].

It is well-known and easy to see that the planar dual of a 3-connected cubic planar bipartite graph is *Eulerian*, i.e., it is connected and all its vertices have even degree. Moreover, the dual will be a planar *triangulation*, i.e., all its faces are triangles. A subset of the vertices of an undirected graph is called *acyclic* if it induces a forest. Finally, one can observe that after dualization one obtains the following equivalent statement of Conjecture 1.

**Conjecture 2** (Dual Barnette). Every Eulerian planar triangulation can be vertex-partitioned into two acyclic sets.

The statement does not hold for general planar triangulations, because then it corresponds to Tait's Conjecture [33]. Indeed, there is a rich literature about decompositions of planar graphs into graphs close to forests, see e.g. [20,22,31,34].

We are now switching to *oriented graphs*, i.e., directed graphs without cycles of length 1 or 2. A subset of the vertices of a directed graph is called *acyclic* if it induces a subdigraph without directed cycles. Another relaxation of Tait's Conjecture is due to Neumann-Lara.

**Conjecture 3** (Neumann-Lara Dicoloring Conjecture, 1985 [29]). Every oriented planar triangulation can be vertex-partitioned into two acyclic sets.

Conjecture 3 is settled in the absence of directed triangles [24] and for oriented graphs on at most 26 vertices [23] but remains widely open. Note that in the primal setting, i.e. in the language of Hamiltonicity of 3-connected graphs, also Conjecture 3 has a formulation and can be seen as a special case of a conjecture of Hochstättler [16] which has been disproved in [23], where a detailed overview of the interplay of these conjectures have been given<sup>1</sup>. Together with results of Steiner [32, Corollary 5.40] it follows that the largest open common special case of these conjectures is equivalent to:

**Conjecture 4** (Eulerian Neumann-Lara). Every Eulerian oriented planar graph can be vertex-partitioned into two acyclic sets.

Here, a connected oriented graph is *Eulerian* if for each of its vertices we have that its out-degree and in-degree are equal. Note that when forgetting the orientations of a Eulerian oriented graph, one obtains a Eulerian undirected graph, but not vice versa. The main definition for the present paper is

**Definition 5** (CAI-partition). A partition  $\mathcal{A} \cup \mathcal{I} = V$  of the vertices of an (oriented) graph  $G = (V, E)$  is a *CAI-partition* if  $\mathcal{A}$  induces a connected acyclic sub(di)graph and  $\mathcal{I}$  is independent.

The connection of CAI-partitions to the above conjectures and simultaneously our central interest in their study is the following observation. For this, recall that every Eulerian planar triangulation has a unique *tripartition*, i.e., a vertex-partitioning into three independent sets.

**Observation 6.** *Let  $G$  be a Eulerian (oriented) planar triangulation with tripartition  $I_1, I_2, I_3$ . If there exists  $1 \leq i \leq 3$  such that  $G - I_i$  has a CAI-partition, then  $G$  can be vertex-partitioned into two acyclic sets  $A_1, A_2$ . Moreover,  $A_1$  is connected and  $A_2$  is a forest containing  $I_i$  for some  $1 \leq i \leq 3$ .*

Observation 6 suggests a way of attacking the notoriously hard Conjecture 2 and Conjecture 4. But what kind of graphs can appear and hence would need to be given a CAI-partition?

**Observation 7.** *An (oriented) graph  $H$  is induced by two parts of the tripartition of a Eulerian (oriented) planar triangulation if and only if  $H$  is a 2-vertex-connected bipartite planar (oriented) graph.*

## Related work

To our knowledge CAI-partitions have been studied only for undirected graphs.

In [1] the authors call a subtree of a Eulerian plane triangulation  $G$  *permeating* if it intersects every face and study the case where the tree avoids one class of the tripartition of  $G$ . More generally, let us call an acyclic connected subgraph  $\mathcal{A}$  of a plane (oriented)  $G$  *permeating* if  $\mathcal{A}$  intersects every face of  $G$ . The following observation makes the connection with CAI-partitions:

**Observation 8.** *Let  $G$  be an undirected Eulerian triangulation with tripartition  $I_1, I_2, I_3$ . If  $\mathcal{A} \cup \mathcal{I}$  is a CAI-partition of  $G - I_i$ , then  $\mathcal{A}$  is a permeating acyclic connected subgraph of  $G$  and every permeating acyclic connected subgraph of  $G$  that avoids  $I_i$  arises like this.*

The negative result [1, Theorem 4] says that for every integer  $k$  there is a properly 3-coloured undirected Eulerian planar triangulation  $G$  such that every permeating tree of  $G$  contains at least  $k$  vertices from each colour class. In particular, there are Eulerian triangulations  $G$  with tripartition  $I_1, I_2, I_3$  such that no  $G - I_i$  admits a CAI-partition. With Observation 7 and Observation 8 the positive result [1, Corollary 2] reads: 2-vertex connected bipartite planar undirected graphs in which every cycle contains a vertex of degree 2 have a CAI-partition.

<sup>1</sup>See also <http://www.cs.toronto.edu/~ahertel/WebPageFiles/Papers/StrengtheningBarnette'sConjecture10.pdf>

CAI-partitions have also been studied in non-planar graphs. Payan and Sakarovitch [30] show that cubic, 2-connected, cyclically 4-edge connected graphs have a CAI-partition if their order is not divisible by 4, but also give examples of order divisible by 4 without CAI-partition. The case of cubic, 2-connected, cyclically 4-edge connected graphs without CAI-partition remains active, see [27,28]. In [8] it is shown NP-hard to decide if a graph (of diameter at most 3) has a CAI-partition.

## Our results

Our first and main positive result can be translated via Observation 7 and Observation 6 into further evidence for Conjecture 4.

**Theorem 9.** *Every planar bipartite 2-vertex-connected subcubic oriented graph has a CAI-partition.*

Our second positive result can be seen as a general contribution to CAI-partitions in undirected graphs and when restricted to bipartite graphs it yields further positive evidence for Conjecture 2 via Observation 7 and Observation 6.

**Theorem 10.** *Every 2-vertex-connected simple series-parallel graph has a CAI-partition.*

We (almost) show the tightness of our positive results by showing that none of the conditions except possibly planarity in Theorem 9 can be dropped, see Lemma 36. See also Question 39.

Finally, in Section 6, we show that the strategy suggested by Observation 6 is doomed to fail for resolving Conjecture 4 and thus its generalization Conjecture 2.

**Theorem 11.** *There exists a Eulerian oriented planar triangulation  $G$  such that for any  $I$  of its tripartition, the induced subgraph  $H = G - I$  admits no CAI-partition.*

As a consequence of Theorem 11 we obtain an oriented strengthening of [1, Theorem 4]:

**Corollary 12.** *For every integer  $k$  there is a properly 3-coloured Eulerian oriented planar triangulation  $G$  such that every permeating acyclic connected subgraph  $\mathcal{A}$  of  $G$  contains at least  $k$  vertices from each colour class.*

## Definitions and notation

Let  $G = (V, E)$  be a (directed) graph. We define the degree  $d_G(u)$ , the in-degree  $d_G^-(u)$ , and out-degree  $d_G^+(u)$ . We will drop the subscript  $G$  when the graph is clear from the context. A  $k$ -vertex (resp.  $k^-$ -vertex,  $k^+$ -vertex) is a vertex of degree  $k$  (resp. at most  $k$ , at least  $k$ ). Let  $G$  be a planar graph. The degree of a face  $f$  in  $G$  is the number of edges of the face. The set of faces of  $G$  is denoted by  $F(G)$ . A  $k$ -face is an induced cycle  $C_k$ .

For every set  $S \subseteq V$ , we denote by  $G - S$  the graph  $G$  where we removed the vertices of  $S$  along with their incident edges.

A *bridge* is an edge whose removal disconnects the graph. A graph with no bridge is *2-edge-connected*.

A *cut-vertex* is a vertex whose removal disconnects the graph. A graph with no cut-vertex is *2-vertex-connected*.

Note that a subcubic graph is 2-vertex-connected if and only if it is 2-edge-connected.

A set of vertices is *separating* if its removal disconnects the graph.

A *cut-set* is a set of vertices that is separating.

Two vertices in  $G$  are said to be at *facial distance  $d$  on a face  $f$*  if they are on the same face  $f$  and their distance is  $d$  in the induced subgraph  $G[f]$ .

When a graph  $G$  is planar, we associate it with one of its plane drawings for simplicity. A triangulation is a maximal planar graph, i.e. a planar graph for adding an edge results into a non-planar graph, or equivalently a planar graph for which every face (also the outerface) is a triangle.

## 2 Proofs of Observations

*Proof of Observation 6.* Take a CAI-partition of  $G - I_i$ . Clearly  $\mathcal{A}$  is a connected acyclic sub(di)graph of  $G$ . Now suppose for a contradiction that  $\mathcal{I} \cup I_i$  induces a (not necessarily directed) cycle  $C$  in  $G$ .

Consider a planar embedding of  $G$ . Since  $\mathcal{A}$  is connected and disjoint from  $C$ , we may assume without loss of generality that all vertices in  $\mathcal{A}$  are outside of  $C$  in the embedding. Let  $v \in C$ . By assumption, the vertex  $v$  and all of its neighbors in  $C$  or inside of  $C$  belong to  $V(G) - \mathcal{A} = \mathcal{I} \cup I_i$ . Note that any two consecutive neighbors of  $v$  are adjacent in  $G$ , since  $G$  is a triangulation. Since  $C$  is a cycle, the vertex  $v$  has at least two neighbors in  $C$  or inside of  $C$ , hence  $G[\mathcal{I} \cup I_i]$  contains a triangle, a contradiction.

Thus,  $A_1 = \mathcal{A}$  and  $A_2 = \mathcal{I} \cup I_i$  partition  $G$  into a connected acyclic set and a forest containing  $I_i$ .  $\square$

*Proof of Observation 7.* We use the following well-known fact: a planar graph is 2-vertex-connected if and only if all its faces are simple cycles, see e.g. [26, Chapter 2]. Let  $G$  be a Eulerian (oriented) planar triangulation and tripartition  $I_1, I_2, I_3$  and  $H = G - I_i$  for some  $1 \leq i \leq 3$ . Clearly,  $H$  is a bipartite planar (oriented) graph. To see that it is 2-vertex-connected, observe that every face of  $H$  consists of the neighbors of a vertex of  $I_i$  in their cyclic ordering. No vertex can appear twice in such a face by simplicity of  $G$ , hence all faces are simple cycles and  $H$  is 2-vertex-connected by the above result.

Conversely, if  $H$  is a planar bipartite 2-vertex-connected graph (let us for a moment forget about orientations), then by adding a vertex  $v_f$  for each face  $f$  of  $H$  and edges between  $v_f$  and the vertices of  $f$ , we obtain a planar triangulation  $G$ , which is simple because all faces are cycles. Moreover, each added  $v_f$  will have even degree since  $H$  is bipartite. For any vertex  $v \in H$  its degree equals the number of faces incident to  $v$  since  $H$  is 2-vertex-connected, so the degree of  $v$  in  $G$  is even. Thus,  $G$  is a Eulerian planar and the added vertices form one of the independent sets in the tripartition of  $G$ . Finally, orient the new edges from  $v_f$  towards an old vertex  $v$  if  $v$  is a source on  $f$  and towards  $v_f$  if  $v$  is a sink on  $f$ . Since on each face the number of sinks and sources is equal, without the still unoriented edges every vertex has now indegree equal to outdegree. It is easy to see that the still unoriented edges form a subgraph all of whose vertices have even degree, hence we can give it a Eulerian orientation to satisfy the statement of the observation.  $\square$

*Proof of Observation 8.* If  $\mathcal{A} \cup \mathcal{I}$  be a CAI-partition of  $G - I_i$ , then by Observation 6  $\mathcal{I} \cup I_i$  is a forest in  $G$  and in particular it cannot contain any face of  $G$ . Hence,  $\mathcal{A}$  is a permeating acyclic connected subgraph of  $G$  that avoids  $I_i$ .

Conversely, if  $\mathcal{A}$  is a permeating acyclic connected subgraph of  $G$  that avoids  $I_i$ . Let  $B = G - \mathcal{A}$  be the remaining vertices of  $G$ . If  $B - I_i$  had an edge  $e$ , then since  $G$  is a Eulerian triangulation and  $I_1, I_2, I_3$  its tripartition, the triangles containing  $e$  would have its third vertex in  $I_i \subseteq B$ . Hence,  $B$  would contain a face. Thus,  $\mathcal{I} = B - I_i$  is independent.  $\square$

## 3 Proof of Theorem 9

We will prove Theorem 9 using a discharging argument. Suppose by contradiction that there exists a counter-example  $G$  of Theorem 9 that minimizes the number of edges and vertices.

We call a 2-vertex *bad* if it is incident to a 6-face, and *good* otherwise. In order to prove the result, we will use the following proposition. Its proof will be given later.

**Proposition 13.** *The graph  $G$  must have the following structural properties.*

- (i) *Two 2-vertices are at distance at least 3 (Lemma 18).*
- (ii) *There are no 4-faces (Lemma 22).*
- (iii) *Two 2-vertices at facial distance 3 cannot both be bad (Lemma 27).*
- (iv) *If an 8-face contains two 2-vertices, then none of them is bad (Lemma 30).*
- (v) *If a 10-face contains three 2-vertices, then at most one of them is bad (Lemma 31).*
- (vi) *A 2-vertex cannot be incident to two 6-faces (Lemma 29).*

*Proof of Theorem 9.* By Euler's formula, we have

$$\sum_{v \in V(G)} (2d(v) - 6) + \sum_{f \in F(G)} (d(f) - 6) = -12 < 0. \quad (1)$$

We assign the charges  $\mu(v) = 2d(v) - 6$  to each vertex  $v \in V(G)$  and  $\mu(f) = d(f) - 6$  to each face  $f \in F(G)$ . Now, we apply the following discharging rule.

**Discharging rule:**

**R0** Each  $8^+$ -face gives 2 to its bad 2-vertices and 1 to its good 2-vertices.

If Proposition 13 holds, then after applying **R0**, we will prove that the remaining charge  $\mu^*$  on each face and each vertex is nonnegative, reaching a contradiction with Equation (1).

**Faces:** Recall that  $G$  is bipartite. So  $d(f)$  is even and  $d(f) \geq 6$  for every  $f \in F(G)$  by Proposition 13(ii).

- Let  $f$  be a 6-face. Its charge is unchanged so  $\mu^*(f) = \mu(f) = d(f) - 6 = 0$ .
- Let  $f$  be an 8-face. By Proposition 13(i),  $f$  is incident to at most two 2-vertices. By Proposition 13(iv), if  $f$  is incident to exactly two 2-vertices, then none of them is bad. Therefore,  $\mu^*(f) \geq 8 - 6 - \max\{2 \cdot 1, 1 \cdot 2\} = 0$ .
- Let  $f$  be a 10-face. By Proposition 13(i),  $f$  is incident to at most three 2-vertices. By Proposition 13(v), if  $f$  is incident to exactly three 2-vertices, then at most one of them is bad. Therefore,  $\mu^*(f) \geq 10 - 6 - \max\{2 \cdot 1 + 1 \cdot 2, 2 \cdot 2\} = 0$ .
- Let  $f$  be a 12-face. By Proposition 13(i)  $f$  is incident to at most four 2-vertices. By Proposition 13(iii), if  $f$  is incident to exactly four 2-vertices, then at most two of them are bad. Therefore,  $\mu^*(f) \geq 12 - 6 - \max\{2 \cdot 1 + 2 \cdot 2, 3 \cdot 2\} = 0$ .
- Let  $f$  be a  $14^+$ -face. By Proposition 13(i),  $f$  is incident to at most  $\lfloor \frac{d(f)}{3} \rfloor$  2-vertices. Therefore,  $\mu^*(f) = d(f) - 6 - 2 \lfloor \frac{d(f)}{3} \rfloor \geq 0$ .

**Vertices:** Let  $v \in V(G)$ ,  $v$  is a  $2^+$ -vertex since  $G$  is 2-vertex-connected.

- Let  $v$  be a 2-vertex. Recall that  $\mu(v) = 2d(v) - 6 = -2$ . Since  $v$  cannot be incident with two 6-faces by Proposition 13(vi), one of the following two cases occur.
  - If  $v$  is incident to a 6-face and an  $8^+$ -face, then it is a bad 2-vertex and it receives 2 from the  $8^+$ -face.
  - If  $v$  is incident to two  $8^+$ -faces, then it is a good 2-vertex and it receives 1 from each incident  $8^+$ -face. Therefore,  $\mu^*(v) = -2 + 1 \cdot 2 = -2 + 2 \cdot 1 = 0$ .
- Let  $v$  be a 3-vertex. Its charge is unchanged so  $\mu^*(v) = \mu(v) = 2d(v) - 6 = 2 \cdot 3 - 6 = 0$ . □

## Structural properties of $G$

To prove Proposition 13, we will study the structural properties of  $G$  in greater detail. For conciseness, we will call the class of oriented planar bipartite 2-vertex-connected subcubic graphs  $\mathcal{F}$  and when we talk about decompositions, we implicitly imply that it must be a partition into a connected acyclic set and an independent set.

**Proof sketch.** Every proof in this section will be by contradiction with the following scheme.

- We build one (or two) graph(s)  $H$  in  $\mathcal{F}$  from  $G$  such that  $|E(H)| + |V(H)| < |E(G)| + |V(G)|$ .
- We use the minimality of  $G$  to obtain a CAI-partition of  $H$ .
- We modify this CAI-partition of  $H$  to obtain a partition  $(\mathcal{A}, \mathcal{I})$  of  $G$  that we claim is a CAI-partition, thus obtaining a contradiction.
- The proofs that this new partition  $(\mathcal{A}, \mathcal{I})$  of  $G$  is a CAI-partition will consist in
  - verifying that vertices in  $\mathcal{I}$  form an independent set;
  - verifying that new connections between vertices in  $\mathcal{A}$  in  $G$  will not create a directed cycle;
  - if some connections between vertices in  $\mathcal{A}$  in  $H$  are not present in  $G$  or if there were two disconnected graph  $H_1$  and  $H_2$ , then we verify that  $\mathcal{A}$  is connected.

To avoid repetitions in this section, we will only argue that  $H \in \mathcal{F}$  for restrictions that are not straightforward from the definition of  $H$ , which most of the time will be 2-vertex-connectivity. Moreover, to help the reader see how the modification of  $G$  to obtain  $H$  preserves the bipartition, the vertices of one part will be labeled  $a_i$  for some indices  $i$ , and the vertices in the other part with  $b_j$  for the other indices  $j$ . We also often use the two following easy observations.

**Observation 14.** *Let  $v \in \mathcal{A}$ . If  $v$  has exactly one neighbor in  $\mathcal{A}$ , then  $\mathcal{A} - \{v\}$  is a connected acyclic set.*

**Observation 15.** *Let  $v \notin \mathcal{A}$ . If  $v$  has exactly one neighbor in  $\mathcal{A}$ , then  $\mathcal{A} \cup \{v\}$  is a connected acyclic set.*

We use edge (resp. path, cycle) instead of arc (resp. directed path, directed cycle), whenever the orientation can be omitted in the proof. We define an  $\mathcal{A}$ -path between  $u$  and  $v$  as a path between  $u$  and  $v$ , where every vertex on this path is in  $\mathcal{A}$ ,  $u, v$  included. We define an  $\mathcal{A}$ -cycle similarly.

Proofs will also come with figures to illustrate the extension of the CAI-partition of  $H$  to  $G$ . Vertices and edges removed from  $G$  to obtain  $H$  will be in red. Vertices and edges added in  $H$  will be in blue. Next to the vertices, we

add labels  $\mathcal{A}$  and  $\mathcal{I}$  in blue according to the CAI-partition in  $H$  and in red for the extension to the CAI-partition in  $G$ . The presence of (directed)  $\mathcal{A}$ -paths highlighted by the proof will be in the figures as (directed) squiggly lines between vertices in  $\mathcal{A}$ .

**Lemma 16.** *There are no adjacent 2-vertices in  $G$ .*

*Proof.* Suppose by contradiction that we have a path  $a_0b_1a_2b_3$  where  $d(b_1) = d(a_2) = 2$  in  $G$ . If  $a_0$  and  $b_3$  are not adjacent, then let  $H = G - \{b_1, a_2\} + \overrightarrow{a_0b_3}$  when  $\overrightarrow{a_0b_3}$  is an arc of  $G$ , otherwise let  $H = G - \{b_1, a_2\} + \overrightarrow{b_3a_0}$ . If  $a_0$  and  $b_3$  are adjacent, then let  $H = G - \{b_1, a_2\}$ . The resulting graph remains subcubic and bipartite. We check that  $H$  is 2-vertex-connected. Indeed, when  $a_0$  and  $b_3$  are not adjacent, replacing the path  $a_0b_1a_2b_3$  by the edge  $a_0b_3$  preserves the connectivity. In the case where  $a_0$  and  $b_3$  are adjacent in  $G$ , if removing  $\{b_1, a_2\}$  creates a bridge in  $H$ , then this bridge along with  $b_1a_2$  must be an edge-cut in  $G$ . We deduce that this edge cut must be  $\{b_1a_2, a_0b_3\}$ . This implies that  $a_0$  or  $b_3$  is a cut-vertex in  $G$ , or that  $G$  is a cycle, a contradiction since  $G$  is 2-vertex-connected and cycles have a decomposition.

Now, let  $(\mathcal{A}, \mathcal{I})$  be a CAI-partition of  $H$ . Since  $a_0$  and  $b_3$  are adjacent in  $H$ , at most one of them can be in  $\mathcal{I}$ .

**Case 1:**  $a_0$  and  $b_3$  are not adjacent in  $G$ . See Figure 1a.

We claim that  $(\mathcal{A}', \mathcal{I}') = (\mathcal{A} \cup \{a_2, b_1\}, \mathcal{I})$  is a CAI-partition of  $G$ . Indeed, it is the case if either  $a_0$  or  $b_3$  is in  $\mathcal{I}$ . If they are both in  $\mathcal{A}$ , then the connectivity of  $\mathcal{A}$  is preserved in  $G$ . Moreover, if there exists a directed  $\mathcal{A}'$ -cycle in  $G$ , then it must also exist in  $H$  thanks to the added arc between  $a_0$  and  $b_3$ .

**Case 2:**  $a_0$  and  $b_3$  are adjacent in  $G$ . See Figure 1b.

If either  $a_0 \in \mathcal{I}$  or  $b_3 \in \mathcal{I}$ , then  $(\mathcal{A} \cup \{b_1, a_2\}, \mathcal{I})$  is a CAI-partition of  $G$ . If they are both in  $\mathcal{A}$ , then  $(\mathcal{A} \cup \{b_1\}, \mathcal{I} \cup \{a_2\})$  is a CAI-partition of  $G$ .  $\square$

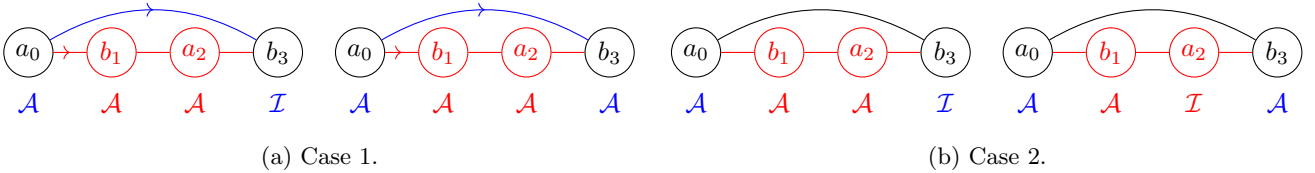

Figure 1: Lemma 16.

Since  $G$  is bipartite, containing a 4-cycle as a subgraph is the same as containing it as an induced subgraph, so there is no ambiguity in the statements that will follow.

**Lemma 17.** *There are no 2-vertices on a 4-cycle in  $G$ .*

*Proof.* Suppose by contradiction that there exists a cycle  $C = a_0b_1a_2b_3$  where  $d(a_0) = 2$ . By Lemma 16,  $d(b_1) = d(b_3) = 3$ . Let  $H = G - \{a_0\}$ . See Figure 2. Observe that  $H$  is 2-vertex-connected. Indeed, if  $H$  is not 2-vertex-connected, then there is a cut-vertex  $v$  in  $H$  such that  $\{v, a_0\}$  is a cut-set in  $G$ . Since removing  $a_0$  could only separate  $b_1$  and  $b_3$ ,  $v$  must be  $a_2$ . However, this implies that  $b_1$  is a cut-vertex in  $G$ , a contradiction.

Let  $(\mathcal{A}, \mathcal{I})$  be a CAI-partition of  $H$ . See Figure 2. If  $b_1$  and  $b_3$  are in  $\mathcal{A}$ , then  $(\mathcal{A}, \mathcal{I} \cup \{a_0\})$  is a CAI-partition of  $G$ . If only one of  $b_1$  and  $b_3$  is in  $\mathcal{A}$ , then  $(\mathcal{A} \cup \{a_0\}, \mathcal{I})$  is a CAI-partition of  $G$ . Finally, suppose  $b_1 \in \mathcal{I}$  and  $b_3 \in \mathcal{I}$ . Since  $(\mathcal{A}, \mathcal{I})$  is a CAI-partition of  $H$ , then  $a_2$  must be in  $\mathcal{A}$  and also must have a third neighbor in  $\mathcal{A}$ . Note that both  $b_1$  and  $b_3$  have degree three by Lemma 16, and thus each has a third neighbor in  $\mathcal{A}$ , which is connected to the rest of  $\mathcal{A}$ . Therefore,  $((\mathcal{A} - \{a_2\}) \cup \{b_1, b_3\}, (\mathcal{I} - \{b_1, b_3\}) \cup \{a_0, a_2\})$  is a CAI-partition of  $G$ .  $\square$

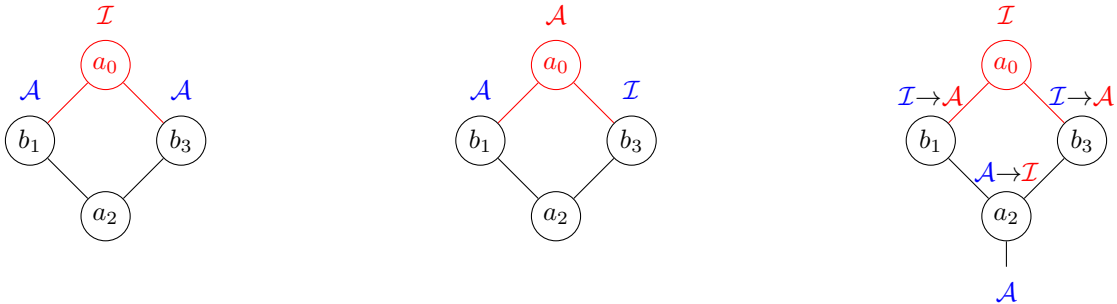

Figure 2: Lemma 17.



**Lemma 18.** *Two 2-vertices are at distance at least 3 in  $G$ .*

*Proof.* Suppose by contradiction that the underlying undirected graph of  $G$  has a path  $a_0b_1a_2b_3a_4$  where  $d(b_1) = d(b_3) = 2$  in  $G$ . By Lemma 16, we know that  $d(a_2) = 3$  so let  $b'_2 \notin \{b_1, b_3\}$  be its third neighbor. By Lemma 17 we know that  $a_0 \neq a_4$ . Let  $H = G - \{b_3\} + \overrightarrow{b_1a_4}$ . By adding the edge  $b_1a_4$ , we ensure the 2-connectivity of  $H$ , otherwise  $b_1a_2$  is a bridge in  $H$  and thus  $a_2b'_2$  is a bridge in  $G$ . Let  $(\mathcal{A}, \mathcal{I})$  be a CAI-partition of  $H$ . We have to distinguish several cases:

**Case 1:** Suppose that  $a_2$  and  $a_4$  are in  $\mathcal{A}$ . See Figure 3a.

If there is an  $\mathcal{A}$ -path between  $a_2$  and  $a_4$  in  $G - \{b_3\}$ , then  $(\mathcal{A}, \mathcal{I} \cup \{b_3\})$  is a CAI-partition of  $G$ . Otherwise,  $(\mathcal{A} \cup \{b_3\}, \mathcal{I})$  is a CAI-partition of  $G$ .

**Case 2:** Suppose that  $a_2 \in \mathcal{A}$  and  $a_4 \in \mathcal{I}$ . See Figure 3b.

In this case,  $(\mathcal{A} \cup \{b_3\}, \mathcal{I})$  is a CAI-partition of  $G$ .

**Case 3:** Suppose that  $a_2 \in \mathcal{I}$  and  $a_4 \in \mathcal{A}$ . See Figure 3c.

Since  $a_2 \in \mathcal{I}$ , we must have  $b_1$  and  $b'_2$  in  $\mathcal{A}$ .

- If there is an  $\mathcal{A}$ -path between  $a_4$  and  $b_1$  in  $G - \{b_3\}$ , then  $(\mathcal{A} \cup \{b_3\}, \mathcal{I})$  is a CAI-partition of  $G$ .
- Otherwise, if there is an  $\mathcal{A}$ -path between  $b'_2$  and  $b_1$  (which must go through  $a_0$ ) in  $G - \{b_3\}$ , then  $((\mathcal{A} - \{b_1\}) \cup \{a_2, b_3\}, (\mathcal{I} - \{a_2\}) \cup \{b_1\})$  is a CAI-partition of  $G$ .
- If both of the previous conditions do not hold, then there must be an  $\mathcal{A}$ -path between  $b'_2$  and  $a_4$  in  $G - \{b_3\}$  since  $\mathcal{A}$  is connected in  $H$ . In this case,  $(\mathcal{A} \cup \{a_2\}, (\mathcal{I} - \{a_2\}) \cup \{b_3\})$  is a CAI-partition of  $G$ .

**Case 4:** Suppose that  $a_2 \in \mathcal{I}$  and  $a_4 \in \mathcal{I}$ . See Figure 3d.

Since  $a_2 \in \mathcal{I}$ , we must have  $b_1$  and  $b'_2$  in  $\mathcal{A}$ . Moreover, there must be an  $\mathcal{A}$ -path between  $b_1$  and  $b'_2$  since  $\mathcal{A}$  is connected in  $H$ . Therefore,  $((\mathcal{A} - \{b_1\}) \cup \{a_2, b_3\}, (\mathcal{I} - \{a_2\}) \cup \{b_1\})$  is a CAI-partition of  $G$ .  $\square$

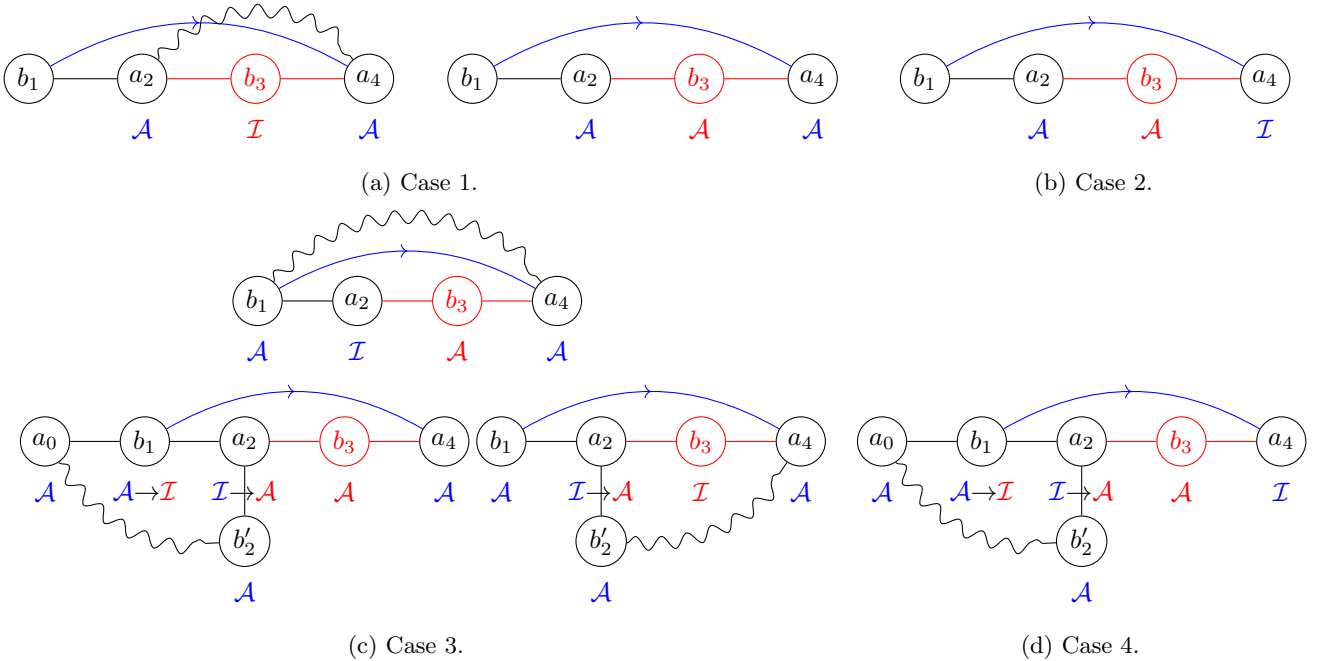

Figure 3: Lemma 18.

To prove that  $G$  contains no 4-faces (Proposition 13(ii)), we need to prove Lemmas 19 to 21 first.

**Lemma 19.** *There are no three distinct 4-cycles in  $G$ , each sharing at least one edge with each other.*

*Proof.* Suppose that such a configuration exists by contradiction. Due to Lemma 17 and the fact that  $G$  is planar, bipartite, subcubic, and 2-vertex-connected, the only possible drawing of such a configuration is presented in Figure 4 along with the name of the vertices. Note that not every  $b'_i$  is necessarily distinct from each other. The three 4-cycles cannot be all directed so let  $C$  be the set of vertices of a non-directed 4-cycle. If every  $b'_i$  is the same vertex, then  $G$  is an orientation of the cube. We can put all of the vertices of  $C$  in  $\mathcal{A}$ , along with two non-adjacent vertices among the



remaining ones, and the last two vertices in  $\mathcal{I}$ , to get a CAI-partition of  $G$ . Therefore we may assume that not every  $b'_i$  is the same vertex.

Let  $H$  be  $G$  where we identify  $a_0, a_1, b_2, a_3, b_4, a_5, b_6$  into one vertex  $a^*$ . If this causes two arcs to be merged into one, we orient it in the opposite direction to the one of the other arc incident to  $a^*$ . Observe that if  $H$  has a bridge, then it must be one that is incident to  $a^*$ , and both arcs incident to  $a^*$  if  $a^*$  has degree 2. But then, one of those arcs would also be a bridge in  $G$ , a contradiction. Therefore,  $H \in \mathcal{F}$ . Let  $(\mathcal{A}, \mathcal{I})$  be a CAI-partition of  $H$ . In what follows, we give a CAI-partition of  $G$  in every possible case up to the symmetry of the configuration.

Observe that  $b'_1, b'_3,$  and  $b'_5$  cannot all be in  $\mathcal{I}$ , otherwise  $a^*$  would be an isolated vertex in  $\mathcal{A}$ . Therefore, we have the following cases.

**Case 1:**  $a^* \in \mathcal{I}$ . See Figure 4a.

We must have  $\{b'_1, b'_3, b'_5\} \subseteq \mathcal{A}$ . By the pigeonhole principle and w.l.o.g. we assume the existence of arcs  $\overrightarrow{a_1 b'_1}$  and  $\overrightarrow{a_3 b'_3}$ . In that case,  $(\mathcal{A} \cup \{a_1, b_2, a_3, b_4, b_6\}, (\mathcal{I} - \{a^*\}) \cup \{a_0, a_5\})$  is a CAI-partition of  $G$ .

**Case 2:**  $a^* \in \mathcal{A}$ . See Figure 4b.

Let  $b \in \{b_2, b_4, b_6\} - C$ .

Suppose first that every  $b'_i$  is distinct. We claim that  $(\mathcal{A}', \mathcal{I}') = ((\mathcal{A} - \{a^*\}) \cup \{a_0, a_1, b_2, a_3, b_4, a_5, b_6\} - \{b\}, \mathcal{I} \cup \{b\})$  is a CAI-partition of  $G$ . The only possible problem with this decomposition is a directed  $\mathcal{A}'$ -cycle. However, any such cycle in  $G$  that contains two of the  $b'_i$ s will be a directed  $\mathcal{A}$ -cycle in  $H$  that goes through  $a^*$ . Moreover, the only other possible directed  $\mathcal{A}'$ -cycle is the 4-cycle that does not contain  $b$ . This is impossible since it is  $C$  which is not directed.

Now suppose not every  $b'_i$  is distinct, say  $b'_1 = b'_3$  without loss of generality. Then we can put another vertex  $\hat{b}$  of  $\{b_2, b_4, b_6\}$  in  $\mathcal{I}'$  without disconnecting  $\mathcal{A}'$ . We choose  $\hat{b}$  so that  $b$  and  $\hat{b}$  are not both adjacent to  $a_5$ . Now  $(\mathcal{A}', \mathcal{I}') = ((\mathcal{A} - \{a^*\}) \cup \{a_0, a_1, b_2, a_3, b_4, a_5, b_6\} - \{b, \hat{b}\}, \mathcal{I} \cup \{b, \hat{b}\})$  is a CAI-partition of  $G$ . The only additional potential directed  $\mathcal{A}'$ -cycle that could appear compared to the previous paragraph is a directed cycle containing  $b'_1 = b'_3$  and not  $b'_5$ . But any such cycle contains either  $b$  or  $\hat{b}$ , which is in  $\mathcal{I}'$ .  $\square$

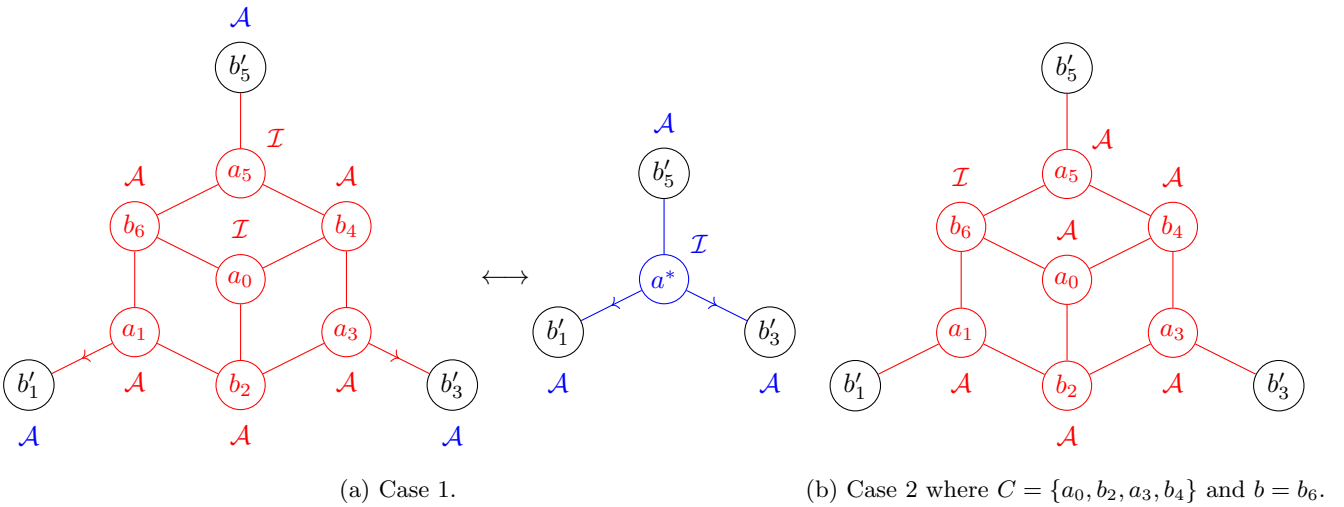

Figure 4: Lemma 19.

Using Lemma 19, we can prove Lemma 20.

**Lemma 20.** *There are not two 4-cycles sharing an edge in  $G$ .*

*Proof.* Suppose that such a configuration exists by contradiction. Note that since  $G$  is 2-connected and planar, there cannot be two 4-cycles that share two edges. We give a drawing of such a configuration in Figure 5 along with the name of the vertices. Let  $H$  be obtained from  $G$  by identifying  $a_1, b_2, a_3$  into a vertex  $a^*$  and  $b_4, a_5, b_6$  into one vertex  $b^*$ , where the direction of the arc between  $a^*$  and  $b^*$  will be chosen later depending on the orientations in  $G$ . By contracting these vertices, we do not create digons due to Lemma 19. Moreover, if we create a bridge, then it is exactly  $a^*b^*$  since otherwise, the same bridge would exist in  $G$ , a contradiction. Therefore, we distinguish two cases.

**Case 1:**  $a^*b^*$  is a bridge. See Figure 5a.

In this case, each component  $H_i$  of  $H - a^*b^*$  is in  $\mathcal{F}$  for  $i \in \{1, 2\}$  since a bridge in  $H_i$  would also exist in  $G$ . Let

$(\mathcal{A}_i, \mathcal{I}_i)$  be a CAI-partition of  $H_i$  for  $i \in \{1, 2\}$ . Now, we have the following cases up to symmetry.

- Suppose that  $a^* \in \mathcal{A}_1$  and  $b^* \in \mathcal{A}_2$ . In this case,  $(\mathcal{A}, \mathcal{I}) = ((\mathcal{A}_1 - \{a^*\}) \cup (\mathcal{A}_2 - \{b^*\}) \cup \{a_1, b_2, a_3, b_4, b_6\}, \mathcal{I}_1 \cup \mathcal{I}_2 \cup \{a_5\})$  is a CAI-partition of  $G$  since  $\mathcal{A}$  is connected and any potential directed  $\mathcal{A}$ -cycle would have existed in  $H_1$  or  $H_2$  by going through either  $a^*$  or  $b^*$ .
- Suppose that  $a^* \in \mathcal{A}_1$  and  $b^* \in \mathcal{I}_2$ . By pigeonhole principle and w.l.o.g., there must be at most one edge  $uv \in \{a_1b_6, b_2a_5, a_3b_4\}$  that is not directed from  $H_1$  towards  $H_2$ . Say that  $v$  is in  $H_2$ . Observe that  $a'_4, a'_6 \in \mathcal{A}_2$  since  $b^* \in \mathcal{I}_2$ . In this case,  $((\mathcal{A}_1 - \{a^*\}) \cup \mathcal{A}_2 \cup \{a_1, b_2, a_3, b_4, a_5, b_6\} - \{v\}, \mathcal{I}_1 \cup (\mathcal{I}_2 - \{b^*\}) \cup \{v\})$  is a CAI-partition of  $G$  since  $\mathcal{A}$  is connected.
- Suppose that  $a^* \in \mathcal{I}_1$  and  $b^* \in \mathcal{I}_2$ . Observe that there exists an  $\mathcal{A}_1$ -path between  $b'_1$  and  $b'_3$  and an  $\mathcal{A}_2$ -path between  $a'_4$  and  $a'_6$  since  $a^* \in \mathcal{I}_1$ ,  $b^* \in \mathcal{I}_2$  and  $\mathcal{A}_1$  and  $\mathcal{A}_2$  are connected. In this case,  $(\mathcal{A}_1 \cup \mathcal{A}_2 \cup \{a_1, b_2, b_4, a_5\}, (\mathcal{I}_1 - \{a^*\}) \cup (\mathcal{I}_2 - \{b^*\}) \cup \{a_3, b_6\})$  is a CAI-partition of  $G$ .

**Case 2:**  $a^*b^*$  is not a bridge. See Figure 5b.

In this case,  $H \in \mathcal{F}$ . Let  $(\mathcal{A}, \mathcal{I})$  be a CAI-partition of  $H$ .

- Suppose that  $a^* \in \mathcal{A}$  and  $b^* \in \mathcal{I}$ . Observe that  $a'_4, a'_6 \in \mathcal{A}$  and therefore  $((\mathcal{A} - \{a^*\}) \cup \{a_1, b_2, a_3, a_5\}, (\mathcal{I} - \{b^*\}) \cup \{b_4, b_6\})$  is a CAI-partition of  $G$ . The same idea holds by symmetry when  $a^* \in \mathcal{I}$  and  $b^* \in \mathcal{A}$ .
- Suppose that  $a^* \in \mathcal{A}$  and  $b^* \in \mathcal{A}$ . We can assume w.l.o.g. that  $\overrightarrow{a_1b_6}$  is an arc in  $G$ .
  - Suppose that  $\overrightarrow{a_3b_4}$  is an arc in  $G$ . In this case, we choose  $\overrightarrow{a^*b^*}$  in  $H$ . Therefore,  $(\mathcal{A}', \mathcal{I}') = ((\mathcal{A} - \{a^*, b^*\}) \cup \{a_1, b_2, a_3, b_4, b_6\}, \mathcal{I} \cup \{a_5\})$  is a CAI-partition of  $G$  since any potential directed  $\mathcal{A}'$ -cycle would have been a directed  $\mathcal{A}$ -cycle in  $H$  by going through  $a^*$  or  $b^*$ .
  - Suppose that  $\overrightarrow{b_4a_3}$  is an arc in  $G$ . W.l.o.g. we assume that  $\overrightarrow{a_5b_2}$  is also an arc in  $G$ . In this case, we choose  $\overrightarrow{b^*a^*}$  in  $H$ . If there are no  $\mathcal{A}$ -paths between  $a'_6$  and  $b'_1, b'_3$ , or  $a'_4$  in  $G - \{a_1, b_2, a_3, b_4, a_5, b_6\}$ , then  $((\mathcal{A} - \{a^*, b^*\}) \cup \{a_1, b_2, a_3, b_4, b_6\}, \mathcal{I} \cup \{a_5\})$  is a CAI-partition of  $G$ . Otherwise,  $((\mathcal{A} - \{a^*, b^*\}) \cup \{a_1, b_2, a_3, b_4, a_5\}, \mathcal{I} \cup \{b_6\})$  is a CAI-partition of  $G$ .  $\square$

Lemma 20 is useful to prove that if there exists a 4-cycle in  $G$ , then it cannot be separating.

**Lemma 21.** *There are no separating 4-cycles in  $G$ .*

*Proof.* Suppose by contradiction that  $G$  contains a separating 4-cycle  $C = a_0b_1a_2b_3$ . Observe that  $G - \{a_0, b_1, a_2, b_3\}$  has exactly two connected components since  $G$  is subcubic and 2-vertex-connected. Let  $S_1$  and  $S_2$  be the set of vertices of those two connected components. Let  $b'_0, a'_1, b'_2, a'_3$  be the neighbors of  $a_0, b_1, a_2, b_3$  respectively. See Figure 6. Since  $G$  is 2-vertex-connected, exactly two of  $\{b'_0, a'_1, b'_2, a'_3\}$  are in the same component. Thus, w.l.o.g. we have the two cases below. By Lemma 20, there are no edges between  $b'_0$  and  $a'_3$ , between  $b'_2$  and  $a'_1$ , between  $b'_0$  and  $a'_1$ , and between  $a'_3$  and  $b'_2$ . Therefore, the graphs that will be defined below are well-defined.

**Case 1:**  $b'_0, a'_1 \in S_1$  and  $b'_2, a'_3 \in S_2$ . See Figure 6a.

W.l.o.g. we assume  $\overrightarrow{a_0b_1}$  is an arc in  $G$ .

- Suppose that we have  $\overrightarrow{a_2b_3}$  in  $G$ . Let  $H = G - \{a_0, b_1, a_2, b_3\} + \overrightarrow{b'_0a'_3} + \overrightarrow{b'_2a'_1}$ . Observe that  $H \in \mathcal{F}$  since  $C$  is separating in  $G$ . Let  $(\mathcal{A}, \mathcal{I})$  be a CAI-partition of  $H$ . Since  $\{\overrightarrow{b'_0a'_3}, \overrightarrow{b'_2a'_1}\}$  is an edge-cut in  $H$  and since  $(\mathcal{A}, \mathcal{I})$  is a CAI-partition of  $H$ , there can be at most one vertex from  $\{b'_0, a'_1, b'_2, a'_3\}$  in  $\mathcal{I}$ . Therefore, we distinguish two cases.
  - Suppose w.l.o.g. that  $b'_0 \in \mathcal{I}$ . In this case,  $(\mathcal{A} \cup \{a_0, b_1, a_2\}, \mathcal{I} \cup \{b_3\})$  is a CAI-partition of  $G$ .
  - Suppose that  $\{b'_0, a'_1, b'_2, a'_3\} \subseteq \mathcal{A}$ . Since  $\mathcal{A}$  is connected, there must be an  $\mathcal{A}$ -path between  $b'_0$  and  $a'_1$  or between  $a'_3$  and  $b'_2$ . Since neither  $(\mathcal{A} \cup \{b_1, a_2, b_3\}, \mathcal{I} \cup \{a_0\})$  nor  $(\mathcal{A} \cup \{a_0, b_1, b_3\}, \mathcal{I} \cup \{a_2\})$  are decompositions of  $G$  and  $C$  is a separating cycle of  $G$ , there must be a directed  $\mathcal{A}$ -path  $\overrightarrow{P_2}$  from  $a'_3$  to  $b'_2$  in  $S_2$  and a directed  $\mathcal{A}$ -path  $\overrightarrow{P_1}$  from  $a'_1$  to  $b'_0$  in  $S_1$ . However, this is impossible because  $\overrightarrow{P_1}b'_0a'_3\overrightarrow{P_2}b'_2a'_1$  is then a directed  $\mathcal{A}$ -cycle in  $H$ .
- Suppose that we have  $\overrightarrow{b_3a_2}$  in  $G$ . Let  $H_1 = S_1 + \overrightarrow{b'_0a'_1}$  and  $H_2 = S_2 + \overrightarrow{a'_3b'_2}$  be the two connected components of  $G - \{a_0, b_1, a_2, b_3\}$ . Observe that  $H_1$  and  $H_2$  are in  $\mathcal{F}$ . Let  $(\mathcal{A}_i, \mathcal{I}_i)$  be a CAI-partition of  $H_i$ , for  $i \in \{1, 2\}$ . We claim that  $(\mathcal{A}, \mathcal{I}) = (\mathcal{A}_1 \cup \mathcal{A}_2 \cup \{a_0, b_1, a_2, b_3\}, \mathcal{I}_1 \cup \mathcal{I}_2)$  is a CAI-partition of  $G$ . Indeed,  $C$  is not a directed cycle,  $\mathcal{A}$  is connected, and any potential directed  $\mathcal{A}$ -cycle in  $G$ , would lead to a directed  $\mathcal{A}_1$ -cycle (resp.  $\mathcal{A}_2$ -cycle) in  $H_1$  (resp.  $H_2$ ) passing through the arc  $\overrightarrow{b'_0a'_1}$  (resp.  $\overrightarrow{a'_3b'_2}$ ).

**Case 2:**  $b'_0, b'_2 \in S_1$  and  $a'_1, a'_3 \in S_2$ . See Figure 6b.

Let  $H = G - \{a_0, b_1, a_2, b_3\} + \overrightarrow{a'_3b'_0} + \overrightarrow{b'_2a'_1}$ . Observe that  $H \in \mathcal{F}$  since  $C$  is separating in  $G$ . Let  $(\mathcal{A}, \mathcal{I})$  be a CAI-partition of  $H$ . Since  $\{\overrightarrow{a'_3b'_0}, \overrightarrow{b'_2a'_1}\}$  is a cut in  $H$  and  $(\mathcal{A}, \mathcal{I})$  is a CAI-partition of  $H$ , there can be at most one vertex from  $\{b'_0, a'_1, b'_2, a'_3\}$  in  $\mathcal{I}$ . Therefore, we distinguish two cases.

- Suppose w.l.o.g. that  $b'_0 \in \mathcal{I}$ . In this case,  $(\mathcal{A} \cup \{a_0, b_1, a_2\}, \mathcal{I} \cup \{b_3\})$  is a CAI-partition of  $G$ .

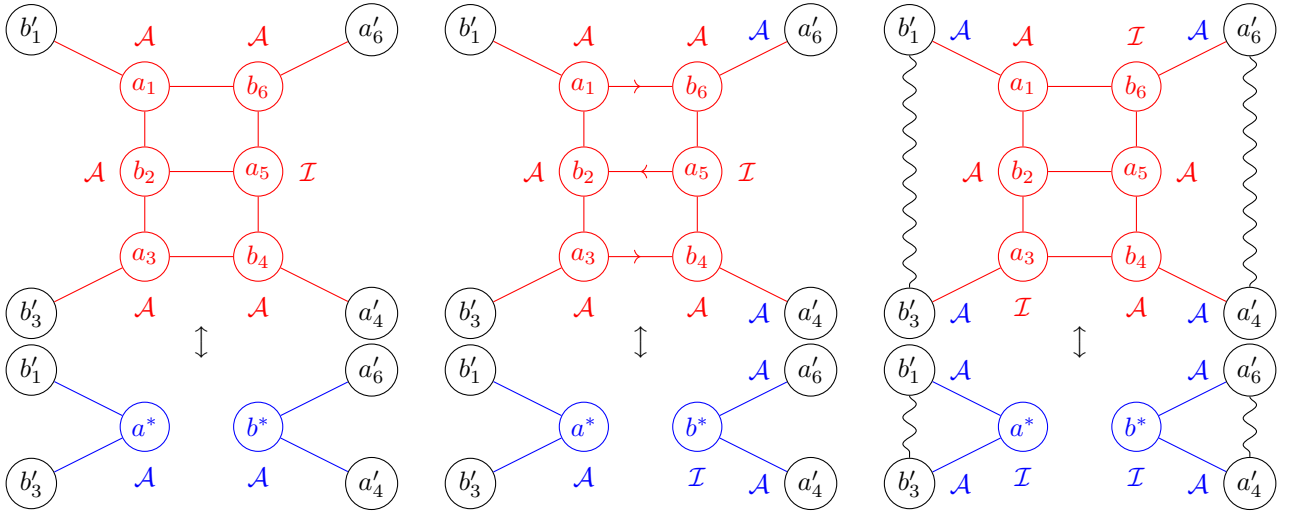

(a) Case 1 where  $v = a_5$  in the second subcase.

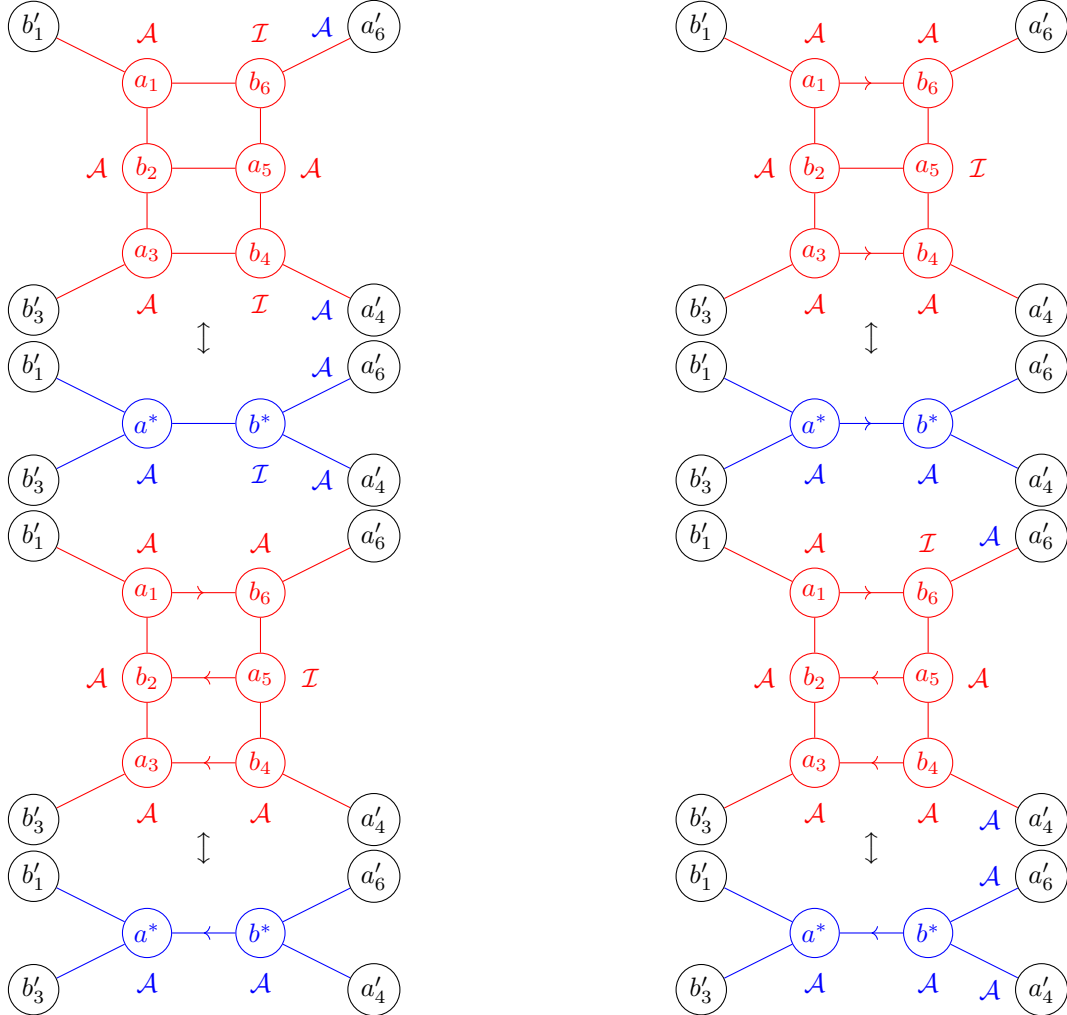

There are no  $\mathcal{A}$ -paths between  $a'_6$  and  $b'_1, b'_3$ , or  $a'_4$  in  $G - \{a_1, b_2, a_3, b_4, a_5, b_6\}$ .

There is an  $\mathcal{A}$ -path between  $a'_6$  and  $b'_1, b'_3$ , or  $a'_4$  in  $G - \{a_1, b_2, a_3, b_4, a_5, b_6\}$ .

(b) Case 2.

Figure 5: Lemma 20.

- Suppose that  $\{b'_0, a'_1, b'_2, a'_3\} \subseteq \mathcal{A}$ . Since  $\mathcal{A}$  is connected, suppose w.l.o.g. that there exists an  $\mathcal{A}$ -path between  $b'_0$  and  $b'_2$ . Since  $(\mathcal{A} \cup \{b_1, a_2, b_3\}, \mathcal{I} \cup \{a_0\})$  and  $(\mathcal{A} \cup \{a_0, b_1, b_3\}, \mathcal{I} \cup \{a_2\})$  are not decompositions of  $G$  and  $C$  is a separating cycle of  $G$ , there must be a directed cycle in  $(\mathcal{A} \cap S_2) \cup \{b_1, a_2, b_3\}$  and  $(\mathcal{A} \cap S_2) \cup \{b_1, a_0, b_3\}$ . Hence  $b_1$  is either a source or a sink in the cycle  $C$ . Therefore,  $(\mathcal{A} \cup \{a_0, b_1, a_2\}, \mathcal{I} \cup \{b_3\})$  is a CAI-partition of  $G$ .  $\square$

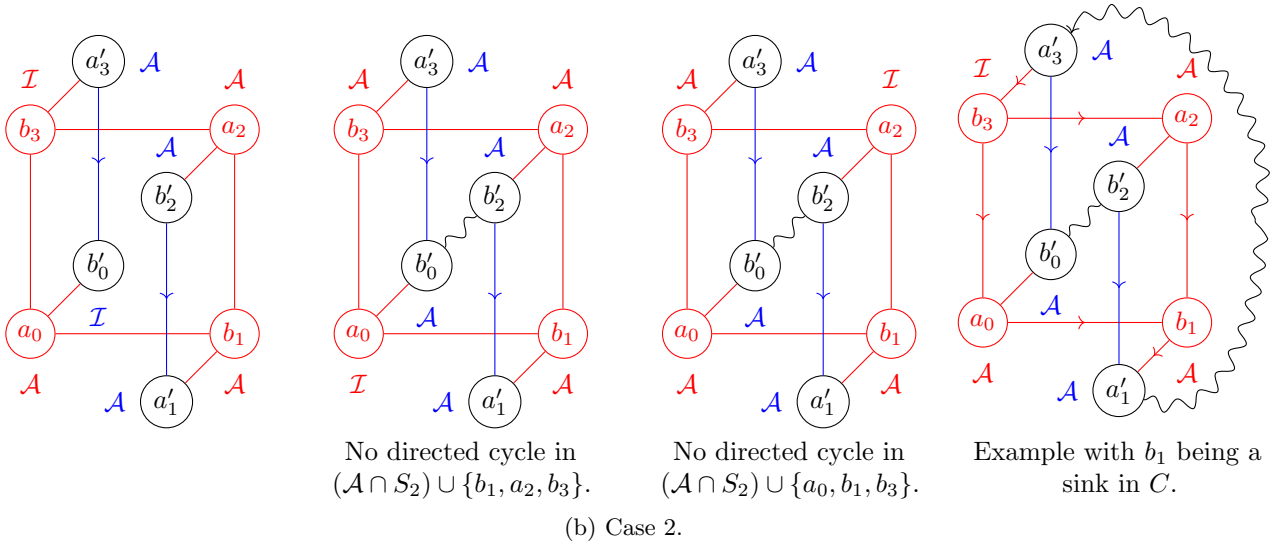
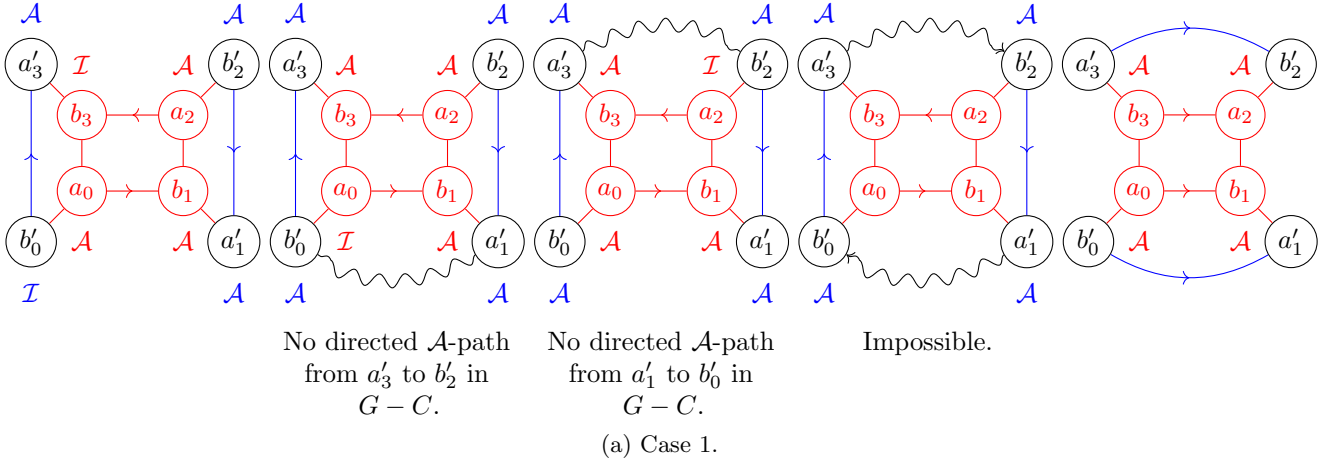

Figure 6: Lemma 21.

Finally, we prove a stronger result than Proposition 13(ii).

**Lemma 22.** *There are no 4-cycles in  $G$ .*

*Proof.* Suppose by contradiction that  $G$  contains a 4-cycle  $C = a_0b_1a_2b_3$ , which by Lemma 21 must be a 4-face. Let  $b'_0, a'_1, b'_2, a'_3$  be the neighbors of  $a_0, b_1, a_2, b_3$  respectively. By Lemma 20, there are no edges between  $b'_0$  and  $a'_3$ , between  $b'_2$  and  $a'_1$ , between  $b'_0$  and  $a'_1$ , and between  $a'_3$  and  $b'_2$ . Therefore, the graphs that will be defined below are well-defined. We begin by showing a useful claim.

**Claim 23.** *The underlying undirected graph  $G - C + b'_0a'_3 + a'_1b'_2$  or  $G - C + b'_0a'_1 + a'_2b'_3$  is 2-vertex-connected. By symmetry, we can assume that  $G - C + b'_0a'_3 + a'_1b'_2$  is 2-vertex-connected.*

*Proof.* By contradiction,  $G$  would contain two edge-cuts of size 3, say  $\{a_0b_3, b_1a_2, w_1w_2\}$  and  $\{b_3a_2, a_0b_1, u_0u_1\}$ , where  $u_0, u_1, w_0, w_1$  are some vertices of  $G$  (see Figure 7). W.l.o.g. suppose that  $\{a_0b_3, b_1a_2, w_1w_2\}$  separates  $G$  into two components with vertex sets  $S_1 \supseteq \{a_0, b_1, w_1, u_0, u_1\}$ ,  $S_2 \supseteq \{a_2, b_3, w_2\}$  and that  $\{b_1a_2, a_0b_3, u_0u_1\}$  separates  $G$  into two components with vertex sets  $T_1 \supseteq \{a_0, b_3, u_0\}$ ,  $T_2 \supseteq \{b_1, a_2, w_1, w_2, u_1\}$ . In this case,  $b_3$  is a cut vertex in  $G$  ( $a'_3 \in T_1 \cap S_2 - \{b_3\}$ ), which contradicts the 2-connectivity of  $G$ .  $\square$

Now, we proceed to the proof of Lemma 22.

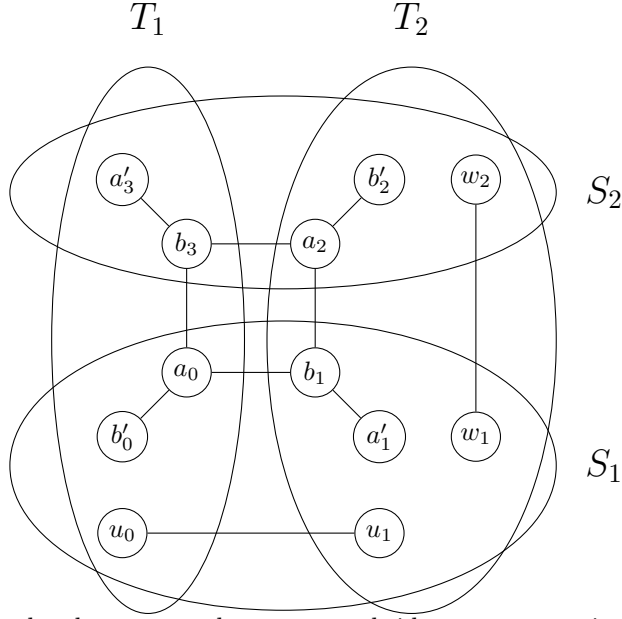
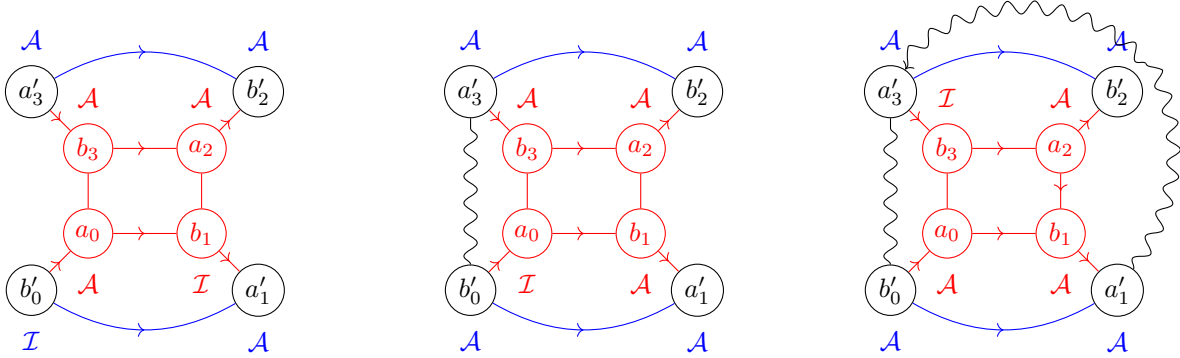

Figure 7: A 4-cycle whose removal creates two bridges must contain a cut-vertex ( $b_3$ ).

**Case 1:** Suppose that  $G$  contains the following arcs  $\overrightarrow{a'_3 b_3}$ ,  $\overrightarrow{b_3 a_2}$ ,  $\overrightarrow{a_2 b_2}$ ,  $\overrightarrow{b'_0 a_0}$ ,  $\overrightarrow{a_0 b_1}$ ,  $\overrightarrow{b_1 a'_1}$  and that  $G - C$  is 2-vertex-connected. Let  $H = G - C + \overrightarrow{a'_3 b'_2} + \overrightarrow{b'_0 a'_1}$ . See Figure 8.

By assumption, we have  $H \in \mathcal{F}$ . Let  $(\mathcal{A}, \mathcal{I})$  be a CAI-partition of  $H$ . Observe that  $|\{b'_0, a'_1, b'_2, a'_3\} \cap \mathcal{A}| \geq 2$  since  $\mathcal{I}$  is an independent set in  $H$ . Thus, we have the following two cases.

- Suppose  $|\{b'_0, a'_1, b'_2, a'_3\} \cap \mathcal{A}| \leq 3$ . W.l.o.g. we can assume that  $b'_0 \in \mathcal{I}$  and therefore  $a'_1 \in \mathcal{A}$ . We claim that  $(\mathcal{A}', \mathcal{I}') = (\mathcal{A} \cup \{a_0, a_2, b_3\}, \mathcal{I} \cup \{b_1\})$  is a CAI-partition of  $G$ . Indeed,  $\mathcal{A}'$  is connected and any possibly directed  $\mathcal{A}'$ -cycle in  $G$  would contain  $\overrightarrow{b_3 a_2}$ , but then  $H$  would contain a directed  $\mathcal{A}$ -cycle containing  $\overrightarrow{a'_3 b'_2}$ .
- Suppose  $|\{b'_0, a'_1, b'_2, a'_3\} \cap \mathcal{A}| = 4$ . Since  $\mathcal{A}$  is connected, by symmetry, in  $G - C$  there exists an  $\mathcal{A}$ -path from  $b'_0$  to  $b'_2$  or  $a'_3$ . Let  $(\mathcal{A}', \mathcal{I}') = (\mathcal{A} \cup \{b_1, a_2, b_3\}, \mathcal{I} \cup \{a_0\})$ . If  $(\mathcal{A}', \mathcal{I}')$  is a CAI-partition of  $G$ , then we are done. Otherwise,  $G$  necessarily contains a directed  $\mathcal{A}'$ -cycle which consists of the arcs  $\overrightarrow{a'_3 b_3}$ ,  $\overrightarrow{b_3 a_2}$ ,  $\overrightarrow{a_2 b_1}$ ,  $\overrightarrow{b_1 a'_1}$  together with a directed  $\mathcal{A}$ -path from  $a'_1$  to  $a'_3$ . In this case  $(\mathcal{A} \cup \{a_0, b_1, a_2\}, \mathcal{I} \cup \{b_3\})$  is a CAI-partition of  $G$ .



No directed  $\mathcal{A}$ -path from  $a'_1$  to  $a'_3$  in  $G - C$ .

Figure 8: Case 1 of Lemma 22.

**Case 2:** Suppose that  $G$  contains the following arcs  $\overrightarrow{a'_3 b_3}$ ,  $\overrightarrow{b_3 a_2}$ ,  $\overrightarrow{a_2 b_2}$ ,  $\overrightarrow{b'_0 a_0}$ ,  $\overrightarrow{a_0 b_1}$ ,  $\overrightarrow{b_1 a'_1}$  and there exists a bridge in  $G - C$ . Together with Claim 23, we conclude that there exists an edge  $e$  in  $G$  such that  $\{a_0 b_3, b_1 a_2, e\}$  is a 3-edge-cut of  $G$ . Let  $H_1$  and  $H_2$  be the two connected subgraphs of  $G - C - e$  with  $H_1$  containing  $a'_0$  and  $b'_1$  and  $H_2$  containing  $b'_2$  and  $a'_3$ . Let  $H'_1$  be obtained by reversing every arc of  $H_1$  and  $H = H'_1 + H_2 + e + \overrightarrow{a'_3 b'_0} + \overrightarrow{a'_1 b'_2}$ . See Figure 9.

Observe that  $H \in \mathcal{F}$  is smaller than  $G$ , so we have a CAI-partition of  $H$ . Observe that  $|\{b'_0, a'_1, b'_2, a'_3\} \cap \mathcal{A}| \geq 2$  since  $\mathcal{I}$  is an independent set in  $H$ . Thus, we have the following two cases.

- Suppose  $|\{b'_0, a'_1, b'_2, a'_3\} \cap \mathcal{A}| \leq 3$ . W.l.o.g. we can assume that  $b'_0 \in \mathcal{I}$  and therefore  $a'_3 \in \mathcal{A}$ . Then  $(\mathcal{A} \cup \{a_0, b_1, a_2\}, \mathcal{I} \cup \{b_3\})$  is a CAI-partition of  $G$ .
- Suppose  $|\{b'_0, a'_1, b'_2, a'_3\} \cap \mathcal{A}| = 4$ . We claim that there cannot be simultaneously a directed  $\mathcal{A}$ -path from  $b'_2$  to  $a'_3$  in  $H_2$  and a directed  $\mathcal{A}$ -path from  $a'_1$  to  $b'_0$  in  $H_1$ . Otherwise, there would be a directed  $\mathcal{A}$ -cycle in  $H$  consisting of

the following: a directed  $\mathcal{A}$ -path from  $b'_2$  to  $a'_3$ ,  $\overrightarrow{a'_3 b'_0}$ , a directed  $\mathcal{A}$ -path from  $b'_0$  to  $a'_1$  (because  $H'_1$  has all arcs reversed with respect to  $H_1$ ). Therefore, we have the two following cases.

- There is a directed  $\mathcal{A}$ -path from  $b'_2$  to  $a'_3$  in  $H_2$  and no directed  $\mathcal{A}$ -paths from  $a'_1$  to  $b'_0$  in  $H_1$ . If  $(\mathcal{A}', \mathcal{I}') = (\mathcal{A} \cup \{a_0, b_1, b_3\}, \mathcal{I} \cup \{a_2\})$  is a CAI-partition of  $G$ , then we are done. Otherwise, there must be a directed  $\mathcal{A}'$ -cycle going through  $a'_3, b_3, a_0, b_1, a'_1$ , and the edge  $e$  oriented from  $H_1$  towards  $H_2$ . However, in this case,  $(\mathcal{A} \cup \{a_0, b_1, a_2\}, \mathcal{I} \cup \{b_3\})$  is a CAI-partition of  $G$ .

The same arguments give a CAI-partition of  $G$  when there is a directed  $\mathcal{A}$ -path from  $a'_1$  to  $b'_0$  in  $H_1$  and no directed  $\mathcal{A}$ -paths from  $b'_2$  to  $a'_3$  in  $H_2$ .

- There are neither directed  $\mathcal{A}$ -paths from  $b'_2$  to  $a'_3$  in  $H_2$ , nor from  $a'_1$  to  $b'_0$  in  $H_1$ . If  $(\mathcal{A} \cup \{a_0, b_1, a_2, b_3\}, \mathcal{I})$  is a CAI-partition of  $G$ , then we are done. Otherwise, if  $e$  is oriented from  $H_1$  towards  $H_2$ , then there must be a directed  $\mathcal{A}$ -cycle going through  $a'_3, b_3, b_1, a'_1$ , and  $e$ . In this case,  $(\mathcal{A} \cup \{a_0, b_1, a_2\}, \mathcal{I} \cup \{b_3\})$  is a CAI-partition of  $G$ . The case when  $e$  is oriented from  $H_2$  towards  $H_1$  is symmetric.

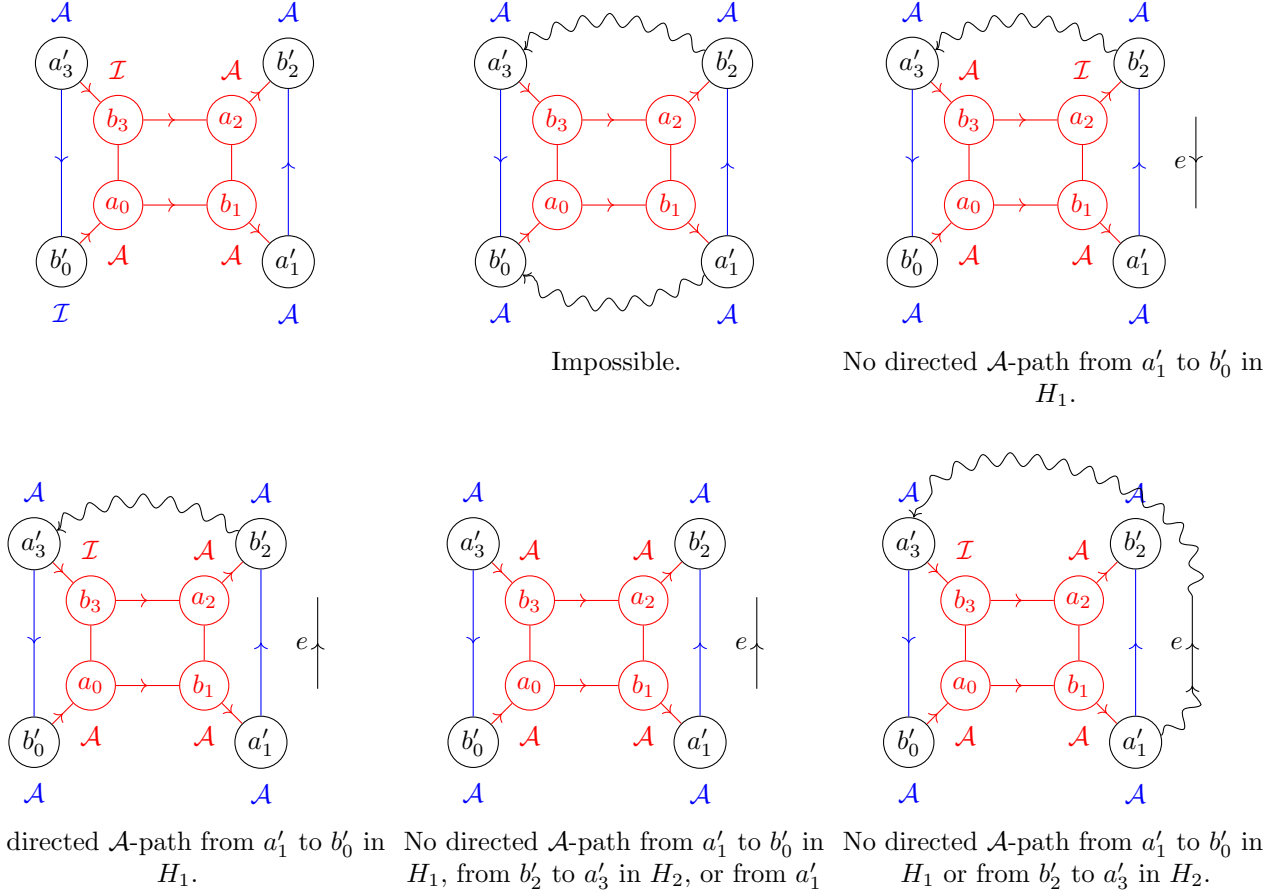

Figure 9: Case 2 of Lemma 22.

**Case 3:** Suppose that we are not in Case 1, nor in Case 2. Suppose w.l.o.g. that  $G$  contains  $\overrightarrow{a_2 b'_2}$ . We define  $H$  depending on the orientation of  $\overrightarrow{a'_3 b_3}$  in  $G$ :

- $\overrightarrow{a'_3 b_3}$  :  $H = G - \{a_0, b_1, a_2, b_3\} + \overrightarrow{a'_1 b'_2} + \overrightarrow{a'_3 b'_0}$ ,
- $b_3 a'_3$  :  $H = G - \{a_0, b_1, a_2, b_3\} + \overrightarrow{a'_1 b'_2} + \overrightarrow{b'_0 a'_3}$ .

See Figure 10.

**Observation 24.** Any directed cycle  $C'$  in  $G$  containing edges  $b'_0 a_0, a_0 b_3, b_3 a'_3$  (resp.  $a'_1 b_1, b_1 a_2, a_2 b'_2$ ) creates a directed cycle  $C' - \{b'_0 a_0, a_0 b_3, b_3 a'_3\} + b'_0 a'_3$  (resp.  $C' - \{a'_1 b_1, b_1 a_2, a_2 b'_2\} + a'_1 b'_2$ ) in  $H$ .

By Claim 23,  $H$  is 2-vertex-connected and is in  $\mathcal{F}$ . Let  $(\mathcal{A}, \mathcal{I})$  be a CAI-partition of  $H$ . Observe that  $|\{b'_0, a'_1, b'_2, a'_3\} \cap \mathcal{A}| \geq 2$  since  $\mathcal{I}$  is an independent set in  $H$ . Thus, we have the following two cases.

- Suppose  $|\{b'_0, a'_1, b'_2, a'_3\} \cap \mathcal{A}| \leq 3$ . W.l.o.g. we can assume that  $b'_0 \in \mathcal{I}$  and therefore  $a'_3 \in \mathcal{A}$ . Then  $(\mathcal{A} \cup \{a_0, b_1, a_2\}, \mathcal{I} \cup \{b_3\})$  is a CAI-partition of  $G$ .
- Suppose  $|\{b'_0, a'_1, b'_2, a'_3\} \cap \mathcal{A}| = 4$ . Now we distinguish the following cases.
  - There exists an  $\mathcal{A}$ -path between  $a'_1$  and  $b'_0$  and an  $\mathcal{A}$ -path between  $a'_3$  and  $b'_2$  in  $G - C$ . If  $\mathcal{A}$  is connected in  $G - C$ , then  $(\mathcal{A} \cup \{a_0, a_2\}, \mathcal{I} \cup \{b_1, b_3\})$  is a CAI-partition of  $G$ . Therefore, there is no  $\mathcal{A}$ -path between  $a'_3$  and  $b'_0$

or  $a'_1$ , as well as between  $b'_2$  and  $b'_0$  or  $a'_1$ . Since  $(\mathcal{A}', \mathcal{I}') = (\mathcal{A} \cup \{a_0, a_2, b_3\}, \mathcal{I} \cup \{b_1\})$  is not a CAI-partition of  $G$ . There must be a directed  $\mathcal{A}'$ -cycle containing  $\overrightarrow{a'_3 b_3}$ ,  $\overrightarrow{b_3 a_2}$ ,  $\overrightarrow{a_2 b'_2}$ , and a directed  $\mathcal{A}$ -path from  $b'_2$  to  $a'_3$ . Similarly, since  $(\mathcal{A}'', \mathcal{I}'') = (\mathcal{A} \cup \{a_0, b_1, b_3\}, \mathcal{I} \cup \{a_2\})$  is not a CAI-partition of  $G$ , there must be an  $\mathcal{A}''$ -cycle containing  $\overrightarrow{a'_1 b_1}$ ,  $\overrightarrow{b_1 a_0}$ ,  $\overrightarrow{a_0 b'_0}$ , and a directed  $\mathcal{A}$ -path from  $b'_0$  to  $a'_1$  (if the arcs were reversed then we would be in **Case 1** or **Case 2**). However, the directed  $\mathcal{A}$ -path from  $b'_0$  to  $a'_1$ ,  $\overrightarrow{a'_1 b'_2}$ , the directed  $\mathcal{A}$ -path from  $b'_2$  to  $a'_3$ , and  $\overrightarrow{a'_3 b'_0}$  form a directed  $\mathcal{A}$ -cycle in  $H$ , a contradiction.

- There exists either an  $\mathcal{A}$ -path between  $a'_1$  and  $b'_0$  or an  $\mathcal{A}$ -path between  $a'_3$  and  $b'_2$  in  $G - C$ . By symmetry, we assume that it is the latter. Since  $(\mathcal{A}', \mathcal{I}') = (\mathcal{A} \cup \{a_0, b_1, a_2\}, \mathcal{I} \cup \{b_3\})$  is not a CAI-partition of  $G$ , there must be a directed  $\mathcal{A}'$ -cycle in  $G$ . This  $\mathcal{A}'$ -cycle cannot contain  $a'_1$  and  $b'_0$  since there is no  $\mathcal{A}$ -path between them in  $G - C$ . This cycle cannot contain  $a'_1$ ,  $b_1$ ,  $a_2$ , and  $b'_2$  by Observation 24. Therefore, this  $\mathcal{A}'$ -cycle contains an  $\mathcal{A}$ -path between  $b'_2$  and  $b'_0$ . Using the same arguments,  $G$  contains an  $\mathcal{A}$ -path between  $a'_1$  and  $a'_3$ . Hence, we go back to the case where  $\mathcal{A}$  is connected in  $G - C$  and  $(\mathcal{A} \cup \{a_0, a_2\}, \mathcal{I} \cup \{b_1, b_3\})$  is a CAI-partition of  $G$ .
- There is no  $\mathcal{A}$ -path between  $a'_1$  and  $b'_0$  and no  $\mathcal{A}$ -path between  $a'_3$  and  $b'_2$  in  $G - C$ . Since  $\mathcal{A}$  must be connected in  $H$ , we can suppose w.l.o.g. that there exists an  $\mathcal{A}$ -path between  $a'_1$  and  $a'_3$ . Since  $(\mathcal{A}', \mathcal{I}') = (\mathcal{A} \cup \{a_0, b_1, a_2\}, \mathcal{I} \cup \{b_3\})$  is not a CAI-partition of  $G$ . There must be a directed  $\mathcal{A}'$ -cycle in  $G$ . This  $\mathcal{A}'$ -cycle cannot contain  $a'_1$  and  $b'_0$  since there is no  $\mathcal{A}$ -path between them in  $G - C$ . This cycle cannot contain  $a'_1$ ,  $b_1$ ,  $a_2$ , and  $b'_2$  by Observation 24. Therefore, this  $\mathcal{A}'$ -cycle contains  $\overrightarrow{b'_0 a_0}$ ,  $\overrightarrow{a_0 b_1}$ ,  $\overrightarrow{b_1 a_2}$ ,  $\overrightarrow{a_2 b'_2}$ , and a directed  $\mathcal{A}$ -path from  $b'_2$  to  $b'_0$  (in particular, the orientations of  $a_0 b_1$ ,  $b_1 a_2$  are forced). Using the same arguments, since  $(\mathcal{A} \cup \{a_0, a_2, b_3\}, \mathcal{I} \cup \{b_1\})$  is not a CAI-partition of  $G$ , we have that  $G$  contains  $\overrightarrow{a_0 b_3}$  and  $\overrightarrow{b_3 a_2}$ . Hence,  $(\mathcal{A} \cup \{a_0, b_1, b_3\}, \mathcal{I} \cup \{a_2\})$  is a CAI-partition of  $G$ .  $\square$

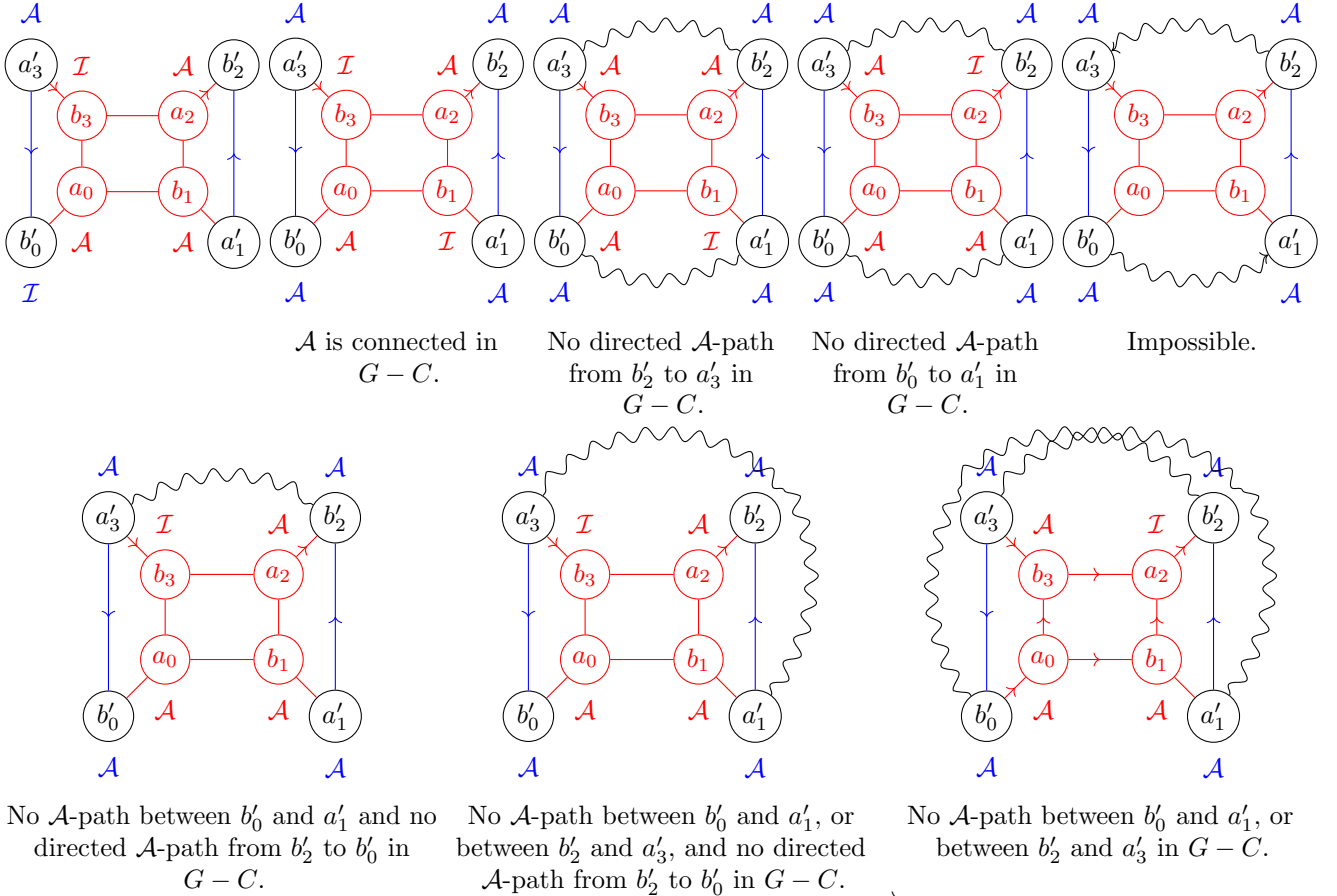

Figure 10: Case 3 of Lemma 22 with  $\overrightarrow{a'_3 b_3}$ .

**Lemma 25.** Let  $u$  and  $v$  be 2-vertices of  $G$ . The following hold:

- (1)  $G - \{u, v\}$  is connected, and
- (2) if  $G - u$  and  $G - v$  are 2-connected, then  $G - \{u, v\}$  is 2-connected.

*Proof.* Let  $H = G - \{u, v\}$ .



First, we show Item (1). Suppose by contradiction that  $H$  is disconnected. We will build  $H' \in \mathcal{F}$  from  $H$  such that  $|V(H')| + |E(H')| < |V(G)| + |E(G)|$  and extend a CAI-partition of  $H'$  to  $G$ , thus obtaining a contradiction. Let  $t$  and  $w$  be neighbors of  $u$  in  $G$ . Suppose that  $u$  is incident to arcs  $\vec{tu}$  and  $\vec{uw}$ . In such case, we add  $\vec{tw}$  to  $H$ , otherwise, we add  $\vec{wt}$  to  $H$ . We do the same between neighbors of  $v$  and obtain  $H'$ . Since  $G \in \mathcal{F}$ ,  $H'$  remains 2-connected, subcubic, oriented, and planar. Moreover, since  $G$  is 2-connected, there are exactly two connected components  $H_1$  and  $H_2$  in  $H$  and  $\{u, v\}$  forms a vertex-cut of  $G$ . Let  $(A, B)$  be the bipartition of  $G$ , let  $(A_1, B_1) = (A \cap V(H_1), B \cap V(H_1))$  and  $(A_2, B_2) = (A \cap V(H_2), B \cap V(H_2))$  be the bipartitions of  $H_1$  and  $H_2$  respectively. Observe that  $(A_1 \cup B_2, B_1 \cup A_2)$  is a bipartition of  $H'$ . Therefore,  $H' \in \mathcal{F}$ . In addition,  $|V(H')| + |E(H')| = |V(G)| + |E(G)| - 4$ . By minimality of  $G$ , there exists a CAI-partition  $(\mathcal{A}, \mathcal{I})$  of  $H'$ . We claim that  $(\mathcal{A}', \mathcal{I}') = (\mathcal{A} \cup \{u, v\}, \mathcal{I})$  is a CAI-partition of  $G$ . Indeed, if it is not a CAI-partition of  $G$ , then it must contain a directed  $\mathcal{A}'$ -cycle going through  $u$  or  $v$ . However, by construction of  $H'$ , if such a directed cycle exists then it must exist in  $\mathcal{A}$ , which contradicts the fact that  $\mathcal{A}$  is an acyclic set.

Now, we show Item (2). Suppose by contradiction that  $H$  is not 2-connected. By Item (1),  $H$  is connected so it must contain a bridge  $\vec{xy}$ . Similarly to the previous case, we will build  $H' \in \mathcal{F}$  from  $H - \vec{xy}$  such that  $|V(H')| + |E(H')| < |V(G)| + |E(G)|$  and extend a CAI-partition of  $H'$  to  $G$ . We add arcs between neighbors of  $u$  and  $v$  in the same fashion as in the proof of Item (1). Moreover, we add a vertex  $z$  with arcs  $\vec{xz}$  and  $\vec{zy}$  to obtain  $H'$ . Moreover, since  $G - u$  and  $G - v$  are 2-connected, there are exactly two connected components  $H_1$  and  $H_2$  in  $H - \vec{xy}$  and  $\{u, v, x\}$  forms a vertex-cut of  $G$ . Let  $(A, B)$  be the bipartition of  $G$ , let  $(A_1, B_1) = (A \cap V(H_1), B \cap V(H_1))$  and  $(A_2, B_2) = (A \cap V(H_2), B \cap V(H_2))$  be the bipartitions of  $H_1$  and  $H_2$  respectively. Suppose w.l.o.g. that  $x \in A_1$ . Observe that  $(A_1 \cup B_2, B_1 \cup A_2 \cup \{z\})$  is a bipartition of  $H'$ . Since  $G \in \mathcal{F}$ , all other properties of  $G$  also remains in  $H'$  so  $H' \in \mathcal{F}$ . In addition,  $|V(H')| + |E(H')| = |V(G)| + |E(G)| - 2$ . By minimality of  $G$ , there exists a CAI-partition  $(\mathcal{A}, \mathcal{I})$  of  $H'$ .

Suppose that  $z \in \mathcal{A}$ . We claim that  $(\mathcal{A}', \mathcal{I}') = ((\mathcal{A} - \{z\}) \cup \{u, v\}, \mathcal{I})$  is a CAI-partition of  $G$ . Similarly to the proof of Item (1), there is no directed  $\mathcal{A}'$ -cycle. Moreover, losing  $z$  does not disconnect  $G[\mathcal{A}']$  since  $x$  and  $y$  would have been in  $\mathcal{A}$ , thus in  $\mathcal{A}'$ , and they are connected by  $\vec{xy}$  in  $G$ .

Suppose that  $z \in \mathcal{I}$ . As a consequence,  $x, y \in \mathcal{A}$ . Since  $(\mathcal{A}', \mathcal{I}') = ((\mathcal{A} - \{z\}) \cup \{u, v\}, \mathcal{I})$  cannot be a CAI-partition of  $G$ , there must be a directed  $\mathcal{A}'$ -cycle going through  $\vec{xy}$ . Since  $\{u, v, x\}$  forms a vertex-cut of  $G$ , such a cycle must go through  $u$  and/or  $v$ . If such a cycle goes through  $u$ , then we put  $u$  in  $\mathcal{I}'$  instead. We do the same for  $v$ . We claim that the resulting partition  $(\mathcal{A}'', \mathcal{I}'')$  is a CAI-partition of  $G$ . Indeed, there are no  $\mathcal{A}''$ -directed cycle by construction of  $\mathcal{A}''$ . Moreover,  $G[\mathcal{A}'']$  must be connected because whenever we put  $u$  in  $\mathcal{I}''$ , the neighbors of  $u$  are in  $\mathcal{A}''$  and they are connected by the path remaining from a directed cycle going through  $\vec{xy}$  and  $u$  in  $\mathcal{A}'$ . The same holds for  $v$ . This concludes the proof of Item (2).  $\square$

**Lemma 26.** *If there exists a path  $a_0b_1a_2b_3a_4b_5$  lying on some  $k$ -face of  $G$  such that vertices  $b_1$  and  $a_4$  are of degree 2, then  $k \geq 8$  and  $G - \{b_1, a_4\}$  has a bridge.*

*Proof.* Suppose by contradiction that it is not true. By Lemmas 16 and 18,  $a_0, a_2, b_3$  and  $b_5$  have degree 3. Moreover, by Lemma 25,  $G - \{b_1, a_4\}$  is connected. We distinguish the following cases:

- (1)  $a_0b_1a_2b_3a_4b_5$  is a 6-face and  $G - \{b_1, a_4\}$  has a bridge, say  $e_1e_2$ . Note that  $e_1, e_2$  are distinct from  $a_0, b_1, a_2, b_3, a_4, b_5$ , since otherwise  $G$  would have already a bridge. Let  $H = G - \{b_1, a_4, e_1e_2\} \cup \{a_0a_2, b_3b_5\}$ , if  $a_0b_1a_2$  (resp.  $b_3a_4b_5$ ) is a directed path, then the arc between  $a_0a_2$  (resp.  $b_3b_5$ ) is oriented in the same direction. Moreover, in  $H$  we replace (w.l.o.g.)  $\vec{e_1e_2}$  by  $\vec{e_1e_3}$  and  $\vec{e_3e_2}$  for a new vertex  $e_3$ . Observe that  $H$  is bipartite and is in  $\mathcal{F}$  and has order one less than  $G$ . Take a CAI-partition  $(\mathcal{A}, \mathcal{I})$  of  $H$ . Then  $(\mathcal{A} \cup \{b_1, a_4\} - \{e_3\}, \mathcal{I} - \{e_3\})$  is a CAI-partition of  $G$ , except plausibly if  $e_3 \in \mathcal{I}$ . In the latter case, a directed cycle in  $\mathcal{A}$  going through  $e_1e_2$  also needs to go through  $a_0b_1a_2$  or  $b_3a_4b_5$ . Now one can add  $b_1$  or/ and  $a_4$  to  $\mathcal{I}$ , to ensure that  $\mathcal{A}$  is acyclic, while keeping  $\mathcal{A}$  connected.
- (2)  $G - \{b_1, a_4\}$  is in  $\mathcal{F}$ . Then let  $H = G - \{b_1, a_4\}$  to which we add the arc  $\vec{a_0b_5}$  if these two vertices are not adjacent in  $G$ . Take a CAI-partition  $(\mathcal{A}, \mathcal{I})$  of  $H$ .

If  $\{a_0, a_2\} \subset \mathcal{I}$ , then all the neighbors of  $a_0$  and  $a_2$  are in  $\mathcal{A}$ . Now since  $\mathcal{A}$  is connected in  $H$ , we get that  $(\mathcal{A} \cup \{b_1, a_2, a_4\} - \{b_3\}, \mathcal{I} \cup \{b_3\} - \{a_2\})$  is a CAI-partition of  $G$ . If  $a_0 \in \mathcal{I}$  and  $a_2 \in \mathcal{A}$ , then depending whether adding  $a_4$  to  $\mathcal{A}$  creates a cycle or not, either  $(\mathcal{A} \cup \{b_1, a_4\}, \mathcal{I})$  or  $(\mathcal{A} \cup \{b_1\}, \mathcal{I} \cup \{a_4\})$  is a CAI-partition of  $G$ . Therefore, we conclude that  $a_0 \in \mathcal{A}$ .

Suppose  $b_5 \in \mathcal{I}$ . Observe that among  $a_2$  and  $b_3$ , at least one must be in  $\mathcal{A}$ . Moreover, since  $\mathcal{A}$  is connected in  $H$  and  $b_5 \in \mathcal{I}$ , there is an  $\mathcal{A}$ -path in  $H$  (and in  $G$ ) from  $a_0$  to every vertex in  $\mathcal{A}$ , in particular to either  $a_2$  or  $b_3$ . Thus we build a CAI-partition  $(\mathcal{A}', \mathcal{I}')$  of  $G$  as follows:

- If  $b_3 \in \mathcal{I}$ , then  $\mathcal{A}' = \mathcal{A} - \{a_2\} \cup \{b_1, b_3, a_4\}$  and  $\mathcal{I}' = \mathcal{I} - \{b_3\} \cup \{a_2\}$ . Note that since the last neighbor of  $b_3$  is in  $\mathcal{A}$ ,  $\mathcal{A}'$  remains connected.
- If  $b_3 \in \mathcal{A}$ , then  $\mathcal{A}' = \mathcal{A} \cup \{a_4\}$ . Now, if  $a_2 \in \mathcal{I}$  add  $b_1$  to  $\mathcal{A}'$  and otherwise add  $b_1$  to  $\mathcal{I}'$ .

We conclude that  $b_5 \in \mathcal{A}$ . Again, observe that among  $a_2$  and  $b_3$ , at least one must be in  $\mathcal{A}$ . And since  $\{a_0, b_5\} \subset \mathcal{A}$ , w.l.o.g. we can assume that  $a_2 \in \mathcal{A}$ . We build a CAI-partition  $(\mathcal{A}', \mathcal{I}')$  of  $G$  as follows:

- If there is an  $\mathcal{A}$ -path between  $a_0$  and  $b_5$  in  $G - \{b_1, a_4\}$ , then :
  - If  $b_3 \in \mathcal{A}$  then  $\mathcal{A}' = \mathcal{A}$  and  $\mathcal{I}' = \mathcal{I} \cup \{b_1, a_4\}$ .
  - If  $b_3 \in \mathcal{I}$ , then  $\mathcal{A}' = \mathcal{A} \cup \{a_4\}$  and  $\mathcal{I}' = \mathcal{I} \cup \{b_1\}$
- If all the  $\mathcal{A}$ -paths from  $a_0$  to  $b_5$  in  $H$  contain  $a_0b_5$ , then since  $\mathcal{A}$  must be connected in  $H$ , either there is an  $\mathcal{A}$ -path in  $G$  from  $a_0$  to  $a_2$  or from  $b_5$  to  $a_2$ , but not both. Therefore:
  - Suppose  $b_3 \in \mathcal{A}$ . Then there is an  $\mathcal{A}$ -path in  $G$  from  $a_0$  to  $b_3$  or from  $b_5$  to  $b_3$ , but not both. For the former we fix  $\mathcal{A}' = \mathcal{A} \cup \{a_4\}$  and  $\mathcal{I}' = \mathcal{I} \cup \{b_1\}$ , while for the latter fix  $\mathcal{A}' = \mathcal{A} \cup \{b_1\}$  and  $\mathcal{I}' = \mathcal{I} \cup \{a_4\}$
  - Suppose  $b_3 \in \mathcal{I}$ .
    - \* If there is an  $\mathcal{A}$ -path in  $G$  from  $a_2$  to  $b_5$ , then there is no  $\mathcal{A}$ -path in  $G$  from  $a_0$  to  $a_2$ . Thus we can fix  $\mathcal{A}' = \mathcal{A} \cup \{b_1, a_4\}$  and  $\mathcal{I}' = \mathcal{I}$ .
    - \* So there is no  $\mathcal{A}$ -path in  $G$  from  $a_2$  to  $b_5$ , and therefore there is an  $\mathcal{A}$ -path in  $G$  from  $a_0$  to  $a_2$  (since  $\mathcal{A}$  is connected in  $H$ ). Let  $a'_3$  be the third neighbor of  $b_3$  other than  $a_2$  and  $a_4$  and note that  $a'_3 \in \mathcal{A}$ . If there is an  $\mathcal{A}$ -path in  $G$  from  $a_2$  to  $a'_3$  then there is one from  $a_0$  to  $a'_3$ . Hence we can fix  $\mathcal{A}' = \mathcal{A} - \{a_2\} \cup \{b_1, b_3, a_4\}$  and  $\mathcal{I}' = \mathcal{I} - \{b_3\} \cup \{a_2\}$ . If there is no  $\mathcal{A}$ -path in  $G$  from  $a_2$  to  $a'_3$  then there is one from  $a'_3$  to  $b_5$ , because  $\mathcal{A}$  must be connected in  $H$ . Hence we can fix  $\mathcal{A}' = \mathcal{A} \cup \{b_3\}$  and  $\mathcal{I}' = \mathcal{I} - \{b_3\} \cup \{b_1, a_4\}$ .  $\square$

**Lemma 27.**  $G$  cannot have two bad 2-vertices at facial distance 3.

*Proof.* Let  $a_0b_1a_2b_3a_4b_5a_6$  be a path lying on some  $k$ -face  $C_k$  of  $G$  such that vertices  $b_1$  and  $a_4$  are 2 vertices incident to  $C_6$ s. Note that  $k \geq 8$  and  $G - \{b_1, a_4\}$  has a bridge by Lemma 26. The union of the  $C_k$  and the two  $C_6$ s form a subgraph where  $a_4$  and  $b_1$  are internal and so since  $G - \{b_1, a_4\}$  has a bridge, there should be an internal component (containing  $a_2, b_3$ ) and an external component (containing  $b_5, a_6, \dots, a_0$ ) once that bridge is removed in  $G - \{b_1, a_4\}$ . Hence the two  $C_6$ s cannot be disjoint and since  $G$  is subcubic, they cannot have a single vertex in common. The internal cycle of the union of the three cycles is hence of order at most 5, contradicting Lemma 22, since  $G$  is bipartite).  $\square$

**Lemma 28.** Let  $b_1a_2b_3a_4b_5a'_1$  be a 6-face in  $G$ , all of whose vertices have degree 3 except from  $a'_1$ . Then a CAI-partition  $(\mathcal{A}, \mathcal{I})$  of  $H = G - \{a'_1\}$ , assuming  $H \in \mathcal{F}$ , satisfies  $\{a_2, b_3, a_4\} \subset \mathcal{A}$  and  $\{b_1, b_5\} \subset \mathcal{I}$ .

*Proof.* See Figure 11. We take  $H = G - \{a'_1\}$  and since  $H \in \mathcal{F}$ , we can consider a CAI-partition  $(\mathcal{A}, \mathcal{I})$  of  $H$ . Observe that if  $\{b_1, b_5\} \subset \mathcal{A}$ , then  $(\mathcal{A}, \mathcal{I} \cup \{a'_1\})$  is a CAI-partition of  $G$ . Also, if  $|\{b_1, b_5\} \cap \mathcal{A}| = 1$ , then  $(\mathcal{A} \cup \{a'_1\}, \mathcal{I})$  is a CAI-partition of  $G$ . Hence  $\{b_1, b_5\} \subset \mathcal{I}$  and therefore  $\{a_0, a_2, a_4, a_6\} \subset \mathcal{A}$ . We claim that  $b_3 \in \mathcal{A}$ . Indeed, if  $b_3 \in \mathcal{I}$  then necessarily  $\{b'_2, b'_4\} \subset \mathcal{A}$ . Therefore  $(\mathcal{A} - \{a_2, a_4\}) \cup \{b_1, b_3, b_5\}, (\mathcal{I} - \{b_1, b_3, b_5\}) \cup \{a_2, a_4, a'_1\}$  is a CAI-partition of  $G$ .  $\square$

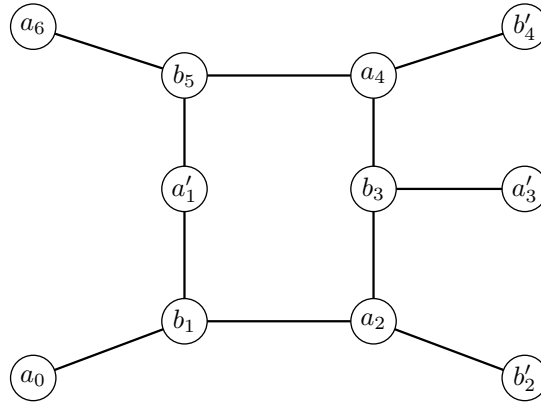

Figure 11: A 2-vertex incident to a 6-face.

**Lemma 29.** A 2-vertex cannot be incident to two 6-faces in  $G$ .

*Proof.* Let  $b_1a_2b_3a_4b_5a'_1$  and  $b_1a'_2b'_3a'_4b_5a'_1$  be the two 6-faces in  $G$ , with  $\deg(a'_1) = 2$  and the other vertices having degree 3 by Lemma 26. Then, by Lemma 28, a CAI-partition  $(\mathcal{A}, \mathcal{I})$  of  $H = G - \{a'_1\}$  satisfies  $\{a_2, b_3, a_4, a'_2, b'_3, a'_4\} \subset \mathcal{A}$  and  $\{b_1, b_5\} \subset \mathcal{I}$ . We define  $b'_2, a'_3$ , and  $b'_4$  as in Figure 11. If we put  $b_1$  in  $\mathcal{A}$ ,  $\mathcal{A}$  is not acyclic anymore. Consider the first edge  $e$  among  $a_2b'_2, b_3a'_3, a_4b'_4$  (in this order) for which a cycle in  $\mathcal{A} \cup \{b_1\}$  exists using that edge. Let  $x = e \cap \{a_2, b_3, a_4\}$ . By the choice of  $e$  and thus  $x$ ,  $\mathcal{A} \cup \{b_1\} - x$  will be acyclic. If  $x = a_4$  or  $\mathcal{A} \cup \{b_1\} - x$  is not connected (and thus  $b'_4, a_4$  are not in the same connected component of  $\mathcal{A} \cup \{b_1\} - x$  as  $b_1$ ), adding  $b_5$  to  $\mathcal{A}$  does not

create a cycle. That is,  $(\mathcal{A} \cup \{b_1, b_5\} - x, \mathcal{I} \cup \{x, a'_1\} - \{b_1, b_5\})$  is a CAI-partition of  $G$ . If  $\mathcal{A} \cup \{b_1\} - x$  is connected and  $x \neq a_4$ , then  $(\mathcal{A} \cup \{b_1, a'_1\} - x, \mathcal{I} \cup x - b_1)$  is a CAI-partition of  $G$ .  $\square$

**Lemma 30.** *If an 8-face contains two 2-vertices, then none of them is bad.*

*Proof.* Assume not. Let  $a_0b_1a_2b_3a_4b_5a_6b_7$  be an 8-face containing two 2-vertices, and assume that  $a_2$  is bad, i.e. is also incident to a 6-face  $b_1a'_1b_2a'_3b_3a_2$ . We consider two cases.

**Case 1: The two 2-vertices on the 8-face have facial distance 3**

Without loss of generality, the two 2-vertices are  $a_2$  and  $b_5$ . See Figure 12, left, for an illustration. By Lemma 26,  $G - \{b_5, a_2\}$  has a bridge. Therefore, by Lemma 25,  $G - b_5$  or  $G - a_2$  has a bridge. The latter cannot happen (since  $a_2$  is lying on a 6-face). Moreover, in the former case, the bridge cannot be an edge of the 6-face, and if either  $b_3a_4$  or  $a_6b_7$  was the bridge, then either  $a_4b'_4$  or  $a_6b'_6$  (respectively) would be a bridge in  $G$ , a contradiction. Therefore,  $G - b_5$  has a bridge and the bridge is either  $b_7a_0$  or  $a_0b_1$ .

**Case 1a:  $\{b_5a_6, b_7a_0\}$  is a cut-set**

Consider the component  $C_1$  containing  $a_6$  and build the graph  $\tilde{C}_1$  by deleting  $a_6$  and  $b_7$  from  $C_1$ , and adding an arc between  $b'_6$  and  $a'_7$  (in the same direction as the path  $b'_6a_6b_7a'_7$  if this path is directed). Note that no digon is created, by Lemma 22. The resulting  $\tilde{C}_1$  is 2-connected and satisfies all properties of Theorem 9 and hence has a CAI-partition  $(\mathcal{A}, \mathcal{I})$ . Now  $(\mathcal{A} \cup \{a_6, b_7\}, \mathcal{I})$  is a CAI-partition of  $C_1$ . Indeed,  $\mathcal{A} \cup \{a_6, b_7\}$  is connected since both  $b'_6$  and  $a'_7$  cannot be in  $\mathcal{I}$  and if it had a directed cycle, then the directed cycle would have been already there in  $\mathcal{A}$  as it would go through the edge  $b'_6a'_7$ .

Consider  $C_2$ , the other component of  $G$ . Add an arc between  $b_5$  and  $a_0$  (in the same direction as the path  $b_5a_6b_7a_0$  in  $G$  if this path is oriented). Again by Theorem 9, there exists a CAI-partition  $(\mathcal{A}_2, \mathcal{I}_2)$  of  $C_2$ . Now  $(\mathcal{A}_2 \cup \mathcal{A} \cup \{a_6, b_7\}, \mathcal{I}_2 \cup \mathcal{I})$  is a CAI-partition of  $G$ .

**Case 1b:  $\{a_0b_1, b_5a_4\}$  is a cut-set**

Recall that  $G - \{a_2\}$  is in  $\mathcal{F}$ . Hence by Lemma 28, we consider a CAI-partition  $(\mathcal{A}, \mathcal{I})$  of  $G - \{a_2\}$  such that  $\{b_1, b_3\} \subset \mathcal{I}$ . Observe that  $\mathcal{A} \cup \{b_1\}$  must contain a cycle as otherwise  $(\mathcal{A} \cup \{b_1, a_2\}, \mathcal{I} - \{b_1\})$  would be a CAI-partition of  $G$ . Hence since  $\{a_0b_1, b_5a_4\}$  is a cut-set, this implies that  $\{a_4, b_5, a_6\} \subset \mathcal{A}$ . Therefore,  $(\mathcal{A} - \{b_5\} \cup \{b_1, a_2\}, \mathcal{I} - \{b_1\} \cup \{b_5\})$  is a CAI-partition of  $G$ .

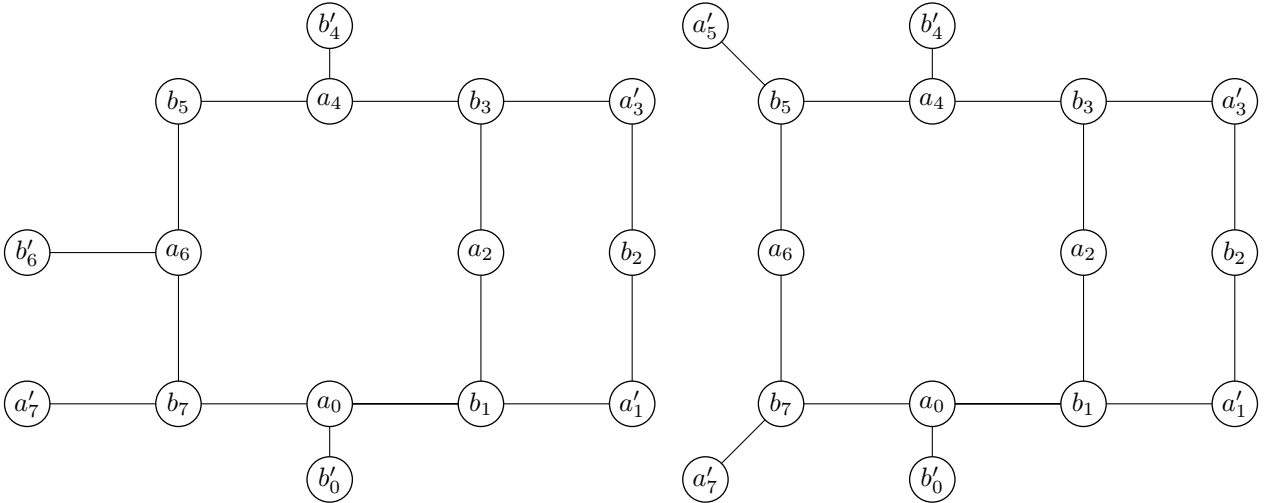

Figure 12: Configurations of Lemma 30

**Case 2: The two 2-vertices on the 8-face have facial distance 4**

See Figure 12, right, for an illustration. By Lemma 28, a CAI-partition  $(\mathcal{A}, \mathcal{I})$  of  $H = G - \{a_2\}$  (which belongs to  $\mathcal{F}$ ) satisfies  $\{a_0, a'_1, b_2, a'_3, a_4\} \subset \mathcal{A}$  and  $\{b_1, b_3\} \subset \mathcal{I}$ . If there is an  $\mathcal{A}$ -path between  $a_0$  and  $a_4$ , containing no vertex from  $\{a'_1, b_2, a'_3\}$ , we are done analogously as in the proof of Lemma 29.

By the previous and the definition of  $(\mathcal{A}, \mathcal{I})$ , there is exactly one of  $\{b_5, a_6, b_7\}$  belonging to  $\mathcal{I}$ .

If  $b_5 \in \mathcal{I}$  (the case  $b_7 \in \mathcal{I}$  is analogous), we can consider  $(\mathcal{A}', \mathcal{I}') = (\mathcal{A} \cup \{a_2, b_3, b_5\} - \{a_4\}, \mathcal{I} - \{b_3, b_5\} \cup \{a_4\})$ . Here  $\mathcal{A}'$  is connected and  $\mathcal{I}'$  is an independent. If  $\mathcal{A}'$  contains a cycle, we can put  $a_6$  in  $\mathcal{I}'$ , i.e. either  $(\mathcal{A}', \mathcal{I}')$  or

$(\mathcal{A}' - a_6, \mathcal{I}' \cup a_6)$  is a CAI-partition of  $G$ .

Finally, we can assume that  $a_6 \in \mathcal{I}$  and  $b_5, b_7 \in \mathcal{A}$ , and recall that every  $\mathcal{A}$ -path from  $a_0$  to  $a_4$  uses at least two vertices out of  $\{a'_1, b_2, a'_3\}$ . By planarity, this implies that there is an  $\mathcal{A}$ -path from  $a_4$  to  $a'_3$  avoiding  $b_2$ , or from  $a_0$  to  $a'_1$  avoiding  $b_2$  (possibly both). By symmetry, we can assume the first. Now choose  $(\mathcal{A}', \mathcal{I}') = (\mathcal{A} \cup \{b_3, a_2\} - \{a'_3\}, \mathcal{I} - \{b_3\} \cup \{a'_3\})$ . Now  $(\mathcal{A}', \mathcal{I}')$  or  $(\mathcal{A}' \cup a_6, \mathcal{I}' - a_6)$  is a CAI-partition of  $G$ .  $\square$

**Lemma 31.** *If a 10-face of  $G$  contains three 2-vertices, then at most one of them is incident to a 6-face.*

*Proof.* Since  $10 = 3 + 3 + 4$  is the only partition of 10 in three integers which are at least 3, these are the facial distances between the three 2-vertices. Assume by contradiction that two of these 2-vertices are bad. Let the  $C_{10}$  be  $a_0b_1a_2b_3 \dots b_9$  and without loss of generality,  $a_2, b_5, a_8$  are the 2-vertices of this  $C_{10}$ . By Lemma 27,  $a_2$  and  $b_5$  (respectively  $b_5$  and  $a_8$ ), are not both bad. So the only case to consider is when the two 2-vertices at facial distance 4,  $a_2$  and  $a_8$ , are both part of a 6-face as well, see Figure 13.

We will use the following claim a few times.

**Claim 32.** *Let  $H \subsetneq G$  contain two adjacent 2-vertices  $u, v$  and satisfy  $H \in \mathcal{F}$ . Then  $H$  has a CAI-partition for which  $u, v \in \mathcal{A}$ .*

*Proof.* Let  $wuvx$  be a path in  $H$ . Add an arc between  $w$  and  $x$  (in the same direction as the path  $wuvx$  in  $H$ , if the path is directed) to  $H - \{u, v\}$ . This is allowed by Lemma 22. Then we created an oriented graph smaller than  $G$  and belonging to  $\mathcal{F}$  which thus has a CAI-partition. Furthermore  $(\mathcal{A} \cup \{u, v\}, \mathcal{I})$  is a CAI-partition of  $H$ .  $\diamond$

By Lemma 26, both  $G - \{a_2, b_5\}$  and  $G - \{a_8, b_5\}$  have a bridge. We now consider two cases.

- Suppose  $G - b_5$  has a bridge. The bridge has to belong to the  $C_{10}$  and thus be  $a_0b_9$  or  $a_0b_1$ . Indeed,  $a_6$  and  $a_4$  cannot be cut-vertices, which excludes  $a_6b_7$  and  $a_4b_3$  being bridges, and the  $C_6$ s around  $a_2$  and  $a_8$  imply that no edge incident with  $a_8$  or  $a_2$  can be a bridge. Note that  $a_0b_9$  and  $a_0b_1$  cannot both be bridges of  $G - b_5$ , since otherwise  $a_0b'_0$  would be a bridge of  $G$ . By symmetry, we can assume that  $G - \{a_0b_9\}$  has two components  $\mathcal{C}_1, \mathcal{C}_2$  (containing  $a_6$  resp.  $a_4$ ), and  $\mathcal{C}_1 \in \mathcal{F}$ .

**Claim 33.** *The component  $\mathcal{C}_1$  has a CAI-partition  $(\mathcal{A}_1, \mathcal{I}_1)$  in which both  $a_6, b_9 \in \mathcal{A}_1$ .*

*Proof.* Either  $\mathcal{C}_1 - \{a_8, b_9\}$  has no bridge, or  $b_8a'_7$  is such a bridge. First assume that deleting  $b_8a'_7$  and  $b_7a_8$  disconnects  $\mathcal{C}_1$ . Then  $\mathcal{C}_1 - \{a_8, b_9\} - \{a'_7b_8\}$  has two components both which have a CAI-partition for which  $a_6, b_7$  resp.  $b_8, a'_9$  belong to the connected acyclic sets by Claim 32. Let  $\mathcal{A}_1$  be the union of the two latter acyclic sets together with  $\{a_8, b_9\}$  (except if this induces a directed cycle in  $\mathcal{A}_1$ , in which case we discard  $a_8$ ) and  $\mathcal{I}_1$  the remaining vertices.

Next, assume that  $\mathcal{C}_1 - \{a_8, b_9\} \in \mathcal{F}$ . Then  $\mathcal{C}_1 - \{a_8, b_9\}$  has a CAI-partition  $(\mathcal{A}_1, \mathcal{I}_1)$  with  $a_6, b_7 \in \mathcal{A}_1$  by Claim 32. Now add  $b_9$  to  $\mathcal{A}_1$ , and also  $a_8$  except if this would lead to a cycle in  $\mathcal{A}_1$  (in which case we add it to  $\mathcal{I}_1$ ).

Under both assumptions,  $(\mathcal{A}_1, \mathcal{I}_1)$  a CAI-partition in which both  $a_6, b_9 \in \mathcal{A}_1$ .  $\diamond$

We modify the other component by adding an arc between  $a_0$  and  $b_5$  (in the direction of the directed  $\mathcal{A}_1$ -path between  $b_9$  and  $a_6$  if there is any). Then it is in  $\mathcal{F}$ . Take a possible CAI-partition  $(\mathcal{A}_2, \mathcal{I}_2)$  of it. Finally consider  $(\mathcal{A}, \mathcal{I}) = (\mathcal{A}_1 \cup \mathcal{A}_2, \mathcal{I}_1 \cup \mathcal{I}_2)$ . If  $(\mathcal{A}, \mathcal{I})$  is not a CAI-partition of  $G$ , then there must be a directed cycle in  $\mathcal{A}$  containing vertices  $a_6, b_5, a_4, a_0, b_9$ . In this case  $(\mathcal{A} - \{b_5\}, \mathcal{I} \cup \{b_5\})$  is a CAI-partition of  $G$  contradicting the assumption that  $G$  is a minimum counterexample to Theorem 9.

- If  $H = G - b_5 \in \mathcal{F}$ , the bridge  $e$  in  $G - \{a_2, b_5\}$  has to belong to the cycle  $C_6$  containing  $a_2$ , and since  $b_1, b_3$  are both not a cut-vertex of  $G - b_5$ , we conclude that the bridge  $e$  contains  $b_2$ . Similarly,  $G - \{b_5, a_8\}$  has a bridge  $e'$  containing  $b_8$ . Now  $G - \{b_5, a_2, a_8, e, e'\}$  has three components;  $\mathcal{C}_1$  containing  $a_6$ ,  $\mathcal{C}_2$  containing  $a_0$  and  $\mathcal{C}_3$  containing  $a_4$ . Checking these components, one can conclude that each  $\mathcal{C}_i$  belongs to  $\mathcal{F}$  for  $i \in [3]$ . Let  $(\mathcal{A}_i, \mathcal{I}_i)$  be a CAI-partition of  $\mathcal{C}_i$ .

By Claim 32, we can assume that  $a_6, b_7 \in \mathcal{A}_1$  and  $a_4, b_3 \in \mathcal{A}_3$ . If  $b_9, b_1 \in \mathcal{I}_2$ , we can update  $(\mathcal{A}_2, \mathcal{I}_2)$  by replacing it by  $(\mathcal{A}_2 \cup \{b_1, b_9\} - \{a_0\}, \mathcal{I}_2 \cup \{a_0\} - \{b_1, b_9\})$ .

Now  $(\mathcal{A}, \mathcal{I}) = (\mathcal{A}_1 \cup \mathcal{A}_2 \cup \mathcal{A}_3 \cup \{a_2, b_5, a_8\}, \mathcal{I}_1 \cup \mathcal{I}_2 \cup \mathcal{I}_3)$  is a partition of  $V(G)$  in a connected set and an independent set. If  $\mathcal{A}$  is not acyclic, the cycles contain at least one vertex of  $\{a_2, b_5, a_8\}$  and one can replace one such vertex a time from  $\mathcal{A}$  to  $\mathcal{I}$  till  $\mathcal{A}$  is acyclic. Once this is the case,  $(\mathcal{A}, \mathcal{I})$  is a CAI-partition of  $G$ .  $\square$

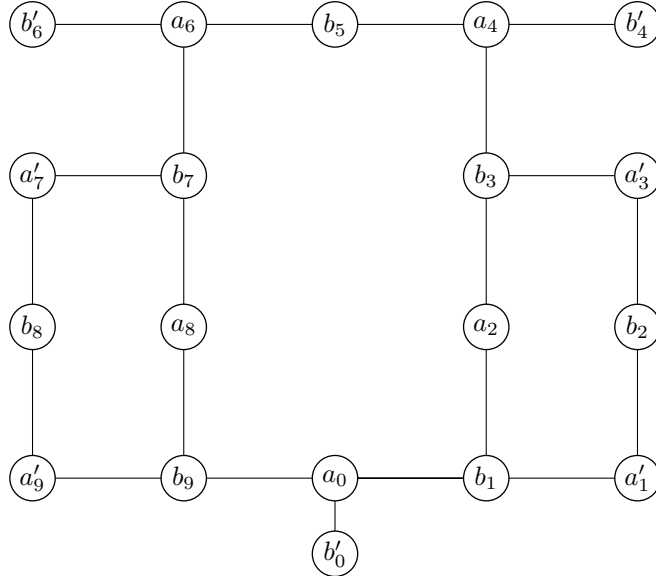

Figure 13: Configuration in Lemma 31

## 4 Proof of Theorem 10

It is well-known that series-parallel graphs contain no subdivisions of a  $K_4$ , see e.g. [4].

Given an undirected graph  $G = (V, E)$ , a partition of its edges into a sequence of *ears*  $ED = (E_0, \dots, E_\ell)$  is an *open ear decomposition* (starting in  $E_0$ ) if:

0.  $E_0$  is a cycle,
1.  $E_i$  is a path with endpoints  $x_i, y_i$ , for  $1 \leq i \leq \ell$ ,
2. the internal vertices of  $E_j$  do not appear in  $E_i$  with  $i < j$ , but the endpoints  $x_j, y_j$  appear in some  $E_k$  and  $E_m$ , for  $0 \leq k, m < j \leq \ell$ .

Further, ED is *nested* if

3. the endpoints  $x_j, y_j$  of  $E_j$  are interior vertices of exactly one ear  $E_i$ , for  $0 \leq i < j \leq \ell$ . We call the  $(x_j, y_j)$ -subpath of  $E_i$  the *nest interval* of  $E_j$  on  $E_i$ ,
4. if  $E_j$  and  $E_k$  both have their endpoints on  $E_i$ , then their nest intervals on  $E_i$  are contained in each other or are internally disjoint.

Additionally, ED is *short* if

5. each  $E_j$  is induced and the nest interval of  $E_j$  on  $E_i$  is not longer than the path  $E_j$ .

A classic result of Whitney [37] shows that a 2-vertex-connected graph on at least 3 vertices has an open ear-decomposition. This has been adapted by Eppstein [9] who showed that a 2-vertex-connected graph is series-parallel if and only if it admits a nested open ear decomposition. We will show the following nice little lemma:

**Lemma 34.** *If  $G$  is a 2-vertex-connected series-parallel then it has a short nested open ear decomposition.*

*Proof.* Since  $G$  is 2-vertex-connected it has a cycle, take a shortest one and use it as  $E_0$ . Given a partial short nested open ear decomposition  $ED' = (E_0, \dots, E_i)$  covering a subgraph  $H \subset G$ , pick any two vertices  $x, y$  of  $H$  such that they are connected with a path only using edges from  $G - E(H)$  and take a shortest such path  $E_{i+1}$ . To see that such  $x, y$  exist is as usual: If there is a vertex  $z \in G - V(H)$  and since  $G$  is 2-vertex connected there must be two paths from  $z$  to  $H$  that only intersect in  $z$ . Their two endpoints are  $x, y$ . Otherwise any edge  $E_{i+1} = \{x, y\}$  of  $G - E(H)$  will do. This yields an open ear decomposition.

Suppose that  $E_k$  is the first ear that does not satisfying 3. or 4. Hence every prior ear has a unique predecessor. If  $E_k$  violates 3., then it has endpoints as interior vertices  $x_k \in E_j$  and  $y_k \in E_i$  for  $i \neq j$ . Note that every vertex is an interior point of some ear, so the endpoints of  $E_k$  must be interior of at least one ear. Let  $E_{i \wedge j}$  be the first common predecessor ear of  $E_i$  and  $E_j$ , in both cases  $E_{i \wedge j} \in \{E_i, E_j\}$  and  $E_{i \wedge j} \notin \{E_i, E_j\}$  it is easy to construct a  $K_4$ -minor, see the left two cases in Figure 14.

If  $E_k$  violates 4., then there are  $E_i, E_j$  such that the nest intervals of  $E_k$  and  $E_j$  on  $E_i$  properly overlap. Also in this case it is easy to find a  $K_4$ -minor, see the right case in Figure 14.

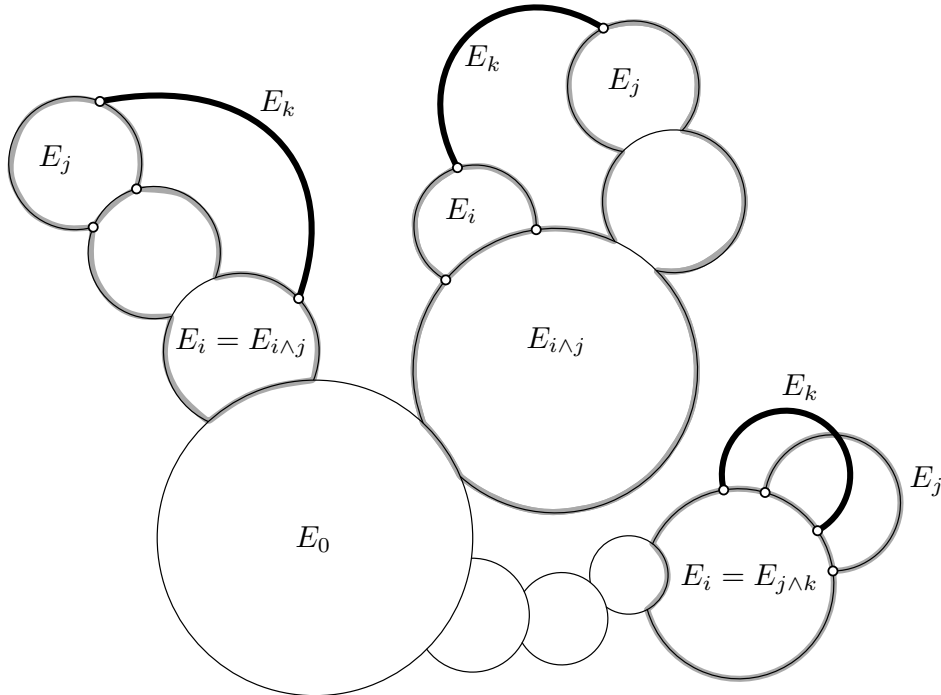

Figure 14: The three ways an ear  $E_k$  can violate properties 3. or 4. and the resulting  $K_4$ -minors in grey.

Let us now prove 5. First, note that by the choice of  $E_k$  as shortest path (or cycle), it clearly is induced. Suppose now that the nest interval  $I$  of  $E_k$  on its unique predecessor ear  $E_j$  is longer than  $E_k$ . But then at the time of constructing  $E_j$  the shorter path  $(E_j - I) \cup E_i$  would have been available, contradicting the minimality in the choice of  $E_j$ .  $\square$

Khuller [21] proposed the definition of *tree ear decomposition*, which are those open ear decompositions additionally satisfying 3. We will call a tree ear decomposition *short* if it furthermore satisfies 5. Clearly, short open nested ear decompositions are short tree ear decompositions. Hence, together with Lemma 34 the following yields Theorem 10.

**Lemma 35.** *If  $G$  is simple and has a short tree ear decomposition, then it has a CAI-partition.*

*Proof.* To prove the theorem go along a short tree ear decomposition ED of  $G$  and construct a CAI-partition with the property that  $\mathcal{I}$  has at most one vertex on each ear. This is easy for  $E_0$  by putting an arbitrary vertex of it into  $\mathcal{I}$ . Note that by 5. every  $E_i$  has some interior vertex, because otherwise its nest interval must also have been an edge, contradicting simplicity. When  $E_i$  is added, then by property 3. at most one of its endpoints is in  $\mathcal{I}$ . If it is exactly one, then just add the vertices of  $E_i$  to  $\mathcal{A}$ . Otherwise choose an internal vertex of  $E_i$  neighboring an endpoint of  $E_i$  and add it to  $\mathcal{I}$ . Clearly, in both cases we maintain that  $\mathcal{I}$  is independent and has at most one vertex on every ear. Moreover, in both cases we add one induced subpath of  $E_i$  which is induced by 5. to  $\mathcal{A}$ . If there was an edge induced from a vertex of  $E_i$  to some previous vertex in  $\mathcal{A}$ , then this must be a later ear, contradicting that the ears in a short tree ear decomposition are not edges.  $\square$

We do not know if there are any interesting graphs apart from the series-parallel ones, that admit short tree ear decompositions. One source is to take a graph with a tree ear decomposition, e.g., any Hamiltonian graph, and subdivide edges sufficiently often so property 5. is satisfied.

## 5 Tightness of Theorems 9 and 10

We discuss the tightness of the results obtained above.

**Lemma 36.** *Each of the graphs of Figure 15 has no CAI-partition.*

*Proof.* We provide the proof for each figure separately.



- (a) To show that the graph of Figure 15a has no CAI-partition we show some properties of the left (resp. right) part of the figure induced by vertices  $\{0, \dots, 7\}$  (resp.  $\{0', \dots, 7'\}$ ). More precisely, we show that for any CAI-partition of the left part, vertices  $\{1, 2\} \not\subset \mathcal{A}$ . Indeed, suppose that there is a CAI-partition such that  $\{1, 2\} \subset \mathcal{A}$ . Since  $0, 3, 2, 1$  is a directed cycle, either  $0 \in \mathcal{I}$  or  $3 \in \mathcal{I}$ . If  $0 \in \mathcal{I}$ , then  $3 \in \mathcal{A}$  and since  $1, 4, 3, 2$  is a directed cycle, we conclude that  $4 \in \mathcal{I}$ . But then vertex 6 has both neighbors in  $\mathcal{I}$  and at the same time  $6 \in \mathcal{A}$  which contradicts the connectivity of  $\mathcal{A}$ . If  $3 \in \mathcal{I}$ , then  $4 \in \mathcal{A}$  and since  $1, 4, 5, 2$  is a directed cycle, we conclude that  $5 \in \mathcal{I}$ . But then vertex 7 has both neighbors in  $\mathcal{I}$  and at the same time  $7 \in \mathcal{A}$  which contradicts the connectivity of  $\mathcal{A}$ . Therefore, for any CAI-partition of the left (resp. right) part, either vertex 1 or 2 (resp.  $1'$  or  $2'$ ) must be in  $\mathcal{I}$ . Hence we obtain a contradiction because  $\mathcal{A}$  is not connected.
- (b) Let  $(\mathcal{A}, \mathcal{I})$  be a CAI-partition of the hypercube. If  $|\mathcal{I}| \leq 2$ , then  $\mathcal{A}$  cannot be acyclic. But if  $|\mathcal{I}| \geq 3$ , then since  $\mathcal{I}$  is independent, there would be an isolated vertex in  $\mathcal{A}$  contradicting the connectivity of  $\mathcal{A}$ . Thus no CAI-partition of the hypercube exists.
- (c), (d) The proofs for Figures 15c and 15d are straightforward.
- (e) Observe that for every directed triangle of Figure 15e, exactly one vertex must be in  $\mathcal{I}$ . Since the graph is symmetric, it is easy to observe that for any choice of these four vertices in  $\mathcal{I}$ , the other vertices form a disconnected graph.  $\square$

Theorem 10 is best possible in the sense that removing any of the restrictions on the graph class provides a counter-example. For instance, the graph of Figure 15b is 2-vertex-connected but of treewidth 3, hence just above 2-vertex-connected series-parallel, which coincides with 2-vertex-connected and treewidth 2. The graph of Figure 15d has treewidth 2 but is not 2-vertex-connected.

As of Theorem 9, we provide a counterexample whenever one of the following restrictions is removed : maximum degree 3 (Figure 15a), oriented (Figures 15b and 15c), 2-vertex-connected (Figure 15d), bipartite (Figure 15e).

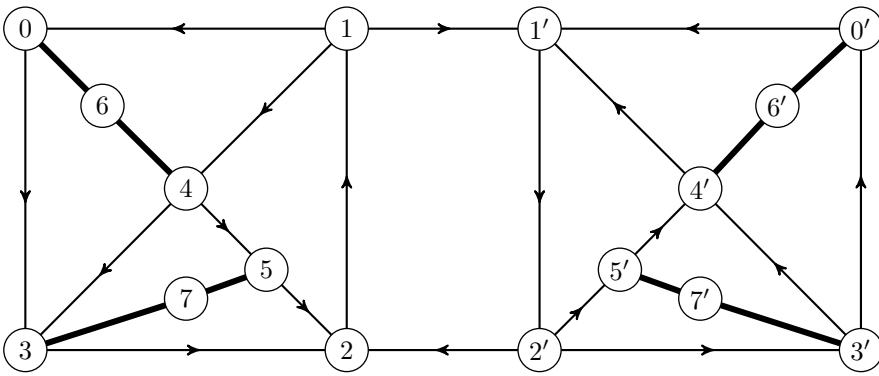

(a) Oriented planar bipartite 2-vertex-connected (with maximum degree 4). The bold edges can be oriented arbitrarily.

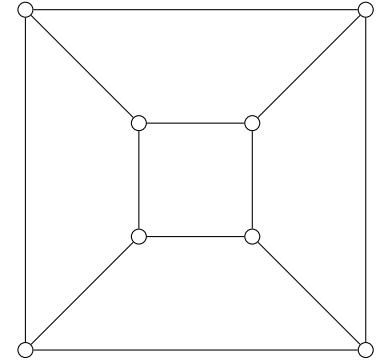

(b) Planar bipartite 2-vertex-connected subcubic (undirected).

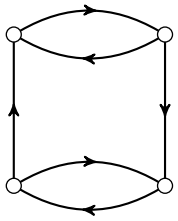

(c) Planar bipartite 2-vertex-connected subcubic (non-oriented).

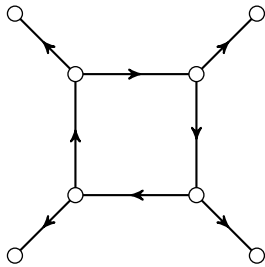

(d) Oriented planar bipartite subcubic (not 2-vertex-connected).

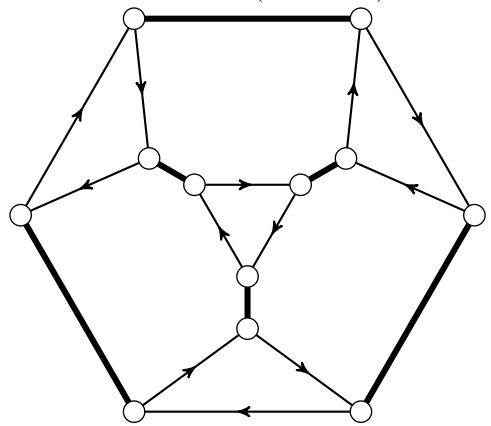

(e) Oriented planar 2-vertex-connected subcubic (not bipartite). The bold edges can be oriented arbitrarily.

Figure 15: Graphs with no CAI-partition.



## 6 Proofs of Theorem 11 and Corollary 12

Note that with the specific properties of a partition resulting from Observation 6 the following show that this strategy will not resolve Conjecture 4 or Conjecture 2, i.e., it yields Theorem 11.

**Theorem 37.** *There exists a Eulerian oriented planar triangulation  $G$  with tripartition  $I_1, I_2, I_3$ , such that every partition of  $G$  into two acyclic sets  $A_1, A_2$  has  $I_i \not\subseteq A_j$  for all  $i \in \{1, 2, 3\}$  and  $j \in \{1, 2\}$ .*

In order to build the graph of Theorem 37, we first provide two useful gadgets.

**Lemma 38.** *Let  $G_1(0, 1, 2, 3)$  and  $G_2(1, 2, 13)$  be the oriented triangulations of Figures 16a and 16b. We have the following properties :*

- (1)  $\forall i \in \{4, \dots, 12\}, d_{G_1}^+(i) = d_{G_1}^-(i), d_{G_2}^+(i) = d_{G_2}^-(i)$ .
- (2)  $d_{G_1}^+(0) = 3, d_{G_1}^-(0) = 2$ .
- (3)  $d_{G_1}^+(1) = 3, d_{G_1}^-(1) = 2$ .
- (4)  $d_{G_1}^+(2) = 2, d_{G_1}^-(2) = 3$ .
- (5)  $d_{G_1}^+(3) = 3, d_{G_1}^-(3) = 4$ .
- (6)  $d_{G_2}^+(1) = 4, d_{G_2}^-(1) = 2$ .
- (7)  $d_{G_2}^+(2) = 3, d_{G_2}^-(2) = 3$ .
- (8)  $d_{G_2}^+(13) = 1, d_{G_2}^-(13) = 3$ .
- (9) *For every partition of  $G_1(0, 1, 2, 3)$  into two acyclic sets  $\mathcal{A}_1$  and  $\mathcal{A}_2$ , if  $\{1, 2\} \subset \mathcal{A}_1$ , then  $\{8, 9, 10, 11, 12\} \not\subseteq \mathcal{A}_2$ .*
- (10) *For every partition of  $G_2(1, 2, 13)$  into two acyclic sets  $\mathcal{A}_1$  and  $\mathcal{A}_2$ , if  $\{1, 2\} \subset \mathcal{A}_1$ , then  $\{8, 9, 10, 11, 12, 13\} \not\subseteq \mathcal{A}_2$ .*

*Proof.* The first eight items can be easily checked on Figures 16a and 16b.

To prove item 9, we proceed by contradiction. Consider a vertex-partition of  $G_1(0, 1, 2, 3)$  into two acyclic sets  $\mathcal{A}_1$  and  $\mathcal{A}_2$  such that  $\{1, 2\} \subset \mathcal{A}_1$  and  $\{8, 9, 10, 11, 12\} \subset \mathcal{A}_2$ . We have the two following cases:

- Suppose  $0 \in \mathcal{A}_2$ . Since  $0, 11, 4, 12$  induce a directed cycle, we know that  $4 \in \mathcal{A}_1$ . But then since  $1, 4, 5, 2$  induce a directed cycle, we know that  $5 \in \mathcal{A}_2$ . Therefore, since  $3, 8, 5, 9$  induce a directed cycle, we know that  $3 \in \mathcal{A}_1$ . This is a contradiction because  $\mathcal{A}_1$  contains the directed cycle  $1, 4, 3, 2$ .
- Suppose  $0 \in \mathcal{A}_1$ . Since  $0, 3, 2, 1$  induce a directed cycle, we know that  $3 \in \mathcal{A}_2$ . Similarly to the previous paragraph we conclude that  $\{4, 5\} \subset \mathcal{A}_1$ . This is a contradiction because  $\mathcal{A}_1$  contains the directed cycle  $1, 4, 5, 2$ .

The proof of item 10 follows the same arguments.  $\square$

*Proof of Theorem 37.* We build  $G$  by gluing the gadgets of Figures 16a and 16b on a Eulerian orientation of the octahedron. See Figure 16c. More precisely we have the following gadgets in  $G$ :

- $G_1(v_6, v_3, v_4, v_7), G_1(v_{10}, v_4, v_5, v_{11}), G_1(v_{14}, v_5, v_3, v_{15}), G_1(v_8, v_0, v_1, v_9), G_1(v_{12}, v_1, v_2, v_{13}), G_1(v_{16}, v_2, v_0, v_{17}),$
- $G_2(v_3, v_0, v_6), G_2(v_0, v_4, v_8), G_2(v_4, v_1, v_{10}), G_2(v_1, v_5, v_{12}), G_2(v_5, v_2, v_{14}), G_2(v_2, v_3, v_{16}).$

Observe that  $G$  is a triangulation. We show that  $G$  is Eulerian, that is  $d^+(v) = d^-(v)$  for every vertex  $v$ . By item 1 of Lemma 38, we have  $d^+(v) = d^-(v)$  for every internal vertex  $v$  (which is not on the outerface of the gadgets). We show that  $d^+(v_i) = d^-(v_i)$  for every  $i \in \{0, \dots, 17\}$ :

- For  $i \in \{6, 8, 10, 12, 14, 16\}$ , by items 2 and 8 of Lemma 38, we have  $d^+(v_i) = d_{G_1}^+(0) + d_{G_2}^+(13) = 3 + 1 = 4 = 2 + 3 - 1 = d_{G_1}^-(0) + d_{G_2}^-(13) - 1$ .
- For  $i \in \{7, 9, 11, 13, 15, 17\}$ , by item 5 of Lemma 38, we have  $d^+(v_i) = d_{G_1}^+(3) + 1 = 3 + 1 = 4 = d_{G_1}^-(3)$ .
- For  $i \in \{0, 1, 2, 3, 4, 5\}$ , by items 3, 4, 6, and 7 of Lemma 38, we have  $d^+(v_i) = d_{G_1}^+(1) + d_{G_2}^+(1) - 1 + d_{G_2}^+(2) + d_{G_1}^+(2) = 3 + 4 - 1 + 3 + 2 = 11 = 2 + 2 + 1 + 3 + 3 = d_{G_1}^-(1) + d_{G_2}^-(1) + 1 + d_{G_2}^-(2) + d_{G_1}^-(2)$ .

Let  $I_1, I_2, I_3$  be the tripartition of  $G$ . It remains to prove that for every partition of  $G$  into two acyclic sets, none of these sets contains  $I_j$  for every  $j \in \{1, 2, 3\}$ . W.l.o.g. let  $\{v_0, v_5, v_9, v_{10}, v_{15}, v_{16}\} \subset I_1$ , let  $\{v_1, v_3, v_7, v_8, v_{13}, v_{14}\} \subset I_2$ , let  $\{v_2, v_4, v_6, v_{11}, v_{12}, v_{17}\} \subset I_3$ . Let  $\mathcal{A}_1, \mathcal{A}_2$  be a vertex-partition of  $G$  into two acyclic sets. By contradiction and by symmetry, we can assume that  $I_1 \subset \mathcal{A}_1$ . Observe that the five internal vertices of  $G_1(v_6, v_3, v_4, v_7)$  corresponding to  $\{8, 9, 10, 11, 12\}$  in Figure 16a must all be in  $\mathcal{A}_1$ . Hence by item 9 of Lemma 38 applied to  $G_1(v_6, v_3, v_4, v_7)$ , we conclude that  $\{v_3, v_4\} \not\subseteq \mathcal{A}_2$  and thus  $\{v_3, v_4\} \cap \mathcal{A}_1 \neq \emptyset$ . Thus, we distinguish the two cases:

- Suppose  $v_3 \in \mathcal{A}_1$ . Since  $v_5 \in \mathcal{A}_1$  and  $v_3, v_5, v_4$  induce a directed triangle, we have  $v_4 \in \mathcal{A}_2$ . Since  $v_0, v_3, v_5, v_1$  induce a directed cycle, we know that vertex  $v_1 \in \mathcal{A}_2$ . This is a contradiction with item 10 of Lemma 38 applied to  $G_2(v_4, v_1, v_{10})$ . Indeed, since the five vertices internal vertices of  $G_2(v_4, v_1, v_{10})$  corresponding to  $\{8, 9, 10, 11, 12, 13\}$  in Figure 16b all belong to  $I_1$ , by hypothesis we know that they all belong to  $\mathcal{A}_1$ . On the other hand, since  $\{v_1, v_4\} \subset \mathcal{A}_2$ , by item 10 of Lemma 38 we know that at least one of these five vertices must be in  $\mathcal{A}_2$ .

- Suppose  $v_4 \in \mathcal{A}_1$ . The proof is very similar to the previous case, due to the symmetry of  $G$ . Since  $v_5 \in \mathcal{A}_1$  and  $v_3, v_5, v_4$  induce a directed triangle, we have  $v_3 \in \mathcal{A}_2$ . Since  $v_0, v_2, v_5, v_4$  induce a directed cycle, vertex  $v_2 \in \mathcal{A}_2$ . This is a contradiction with item 10 of Lemma 38 applied to  $G_2(v_2, v_3, v_{16})$ , because  $v_{16} \in I_1$  but when  $\{v_2, v_3\} \subset \mathcal{A}_2$  we know that  $I_1 \not\subset \mathcal{A}_1$ .  $\square$

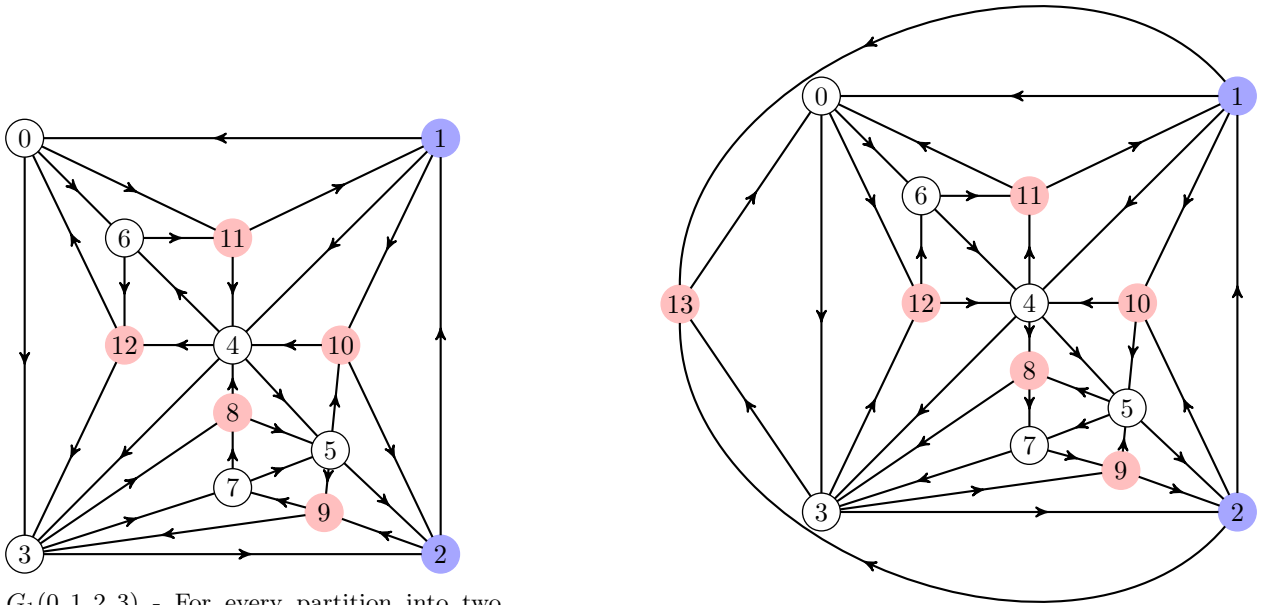

(a)  $G_1(0, 1, 2, 3)$  - For every partition into two acyclic sets  $\mathcal{A}_1$  and  $\mathcal{A}_2$ , if  $\{1, 2\} \subset \mathcal{A}_1$ , then  $\{8, 9, 10, 11, 12\} \not\subset \mathcal{A}_2$ .

(b)  $G_2(1, 2, 13)$  - For every partition into two acyclic sets  $\mathcal{A}_1$  and  $\mathcal{A}_2$ , if  $\{1, 2\} \subset \mathcal{A}_1$ , then  $\{8, 9, 10, 11, 12, 13\} \not\subset \mathcal{A}_2$ .

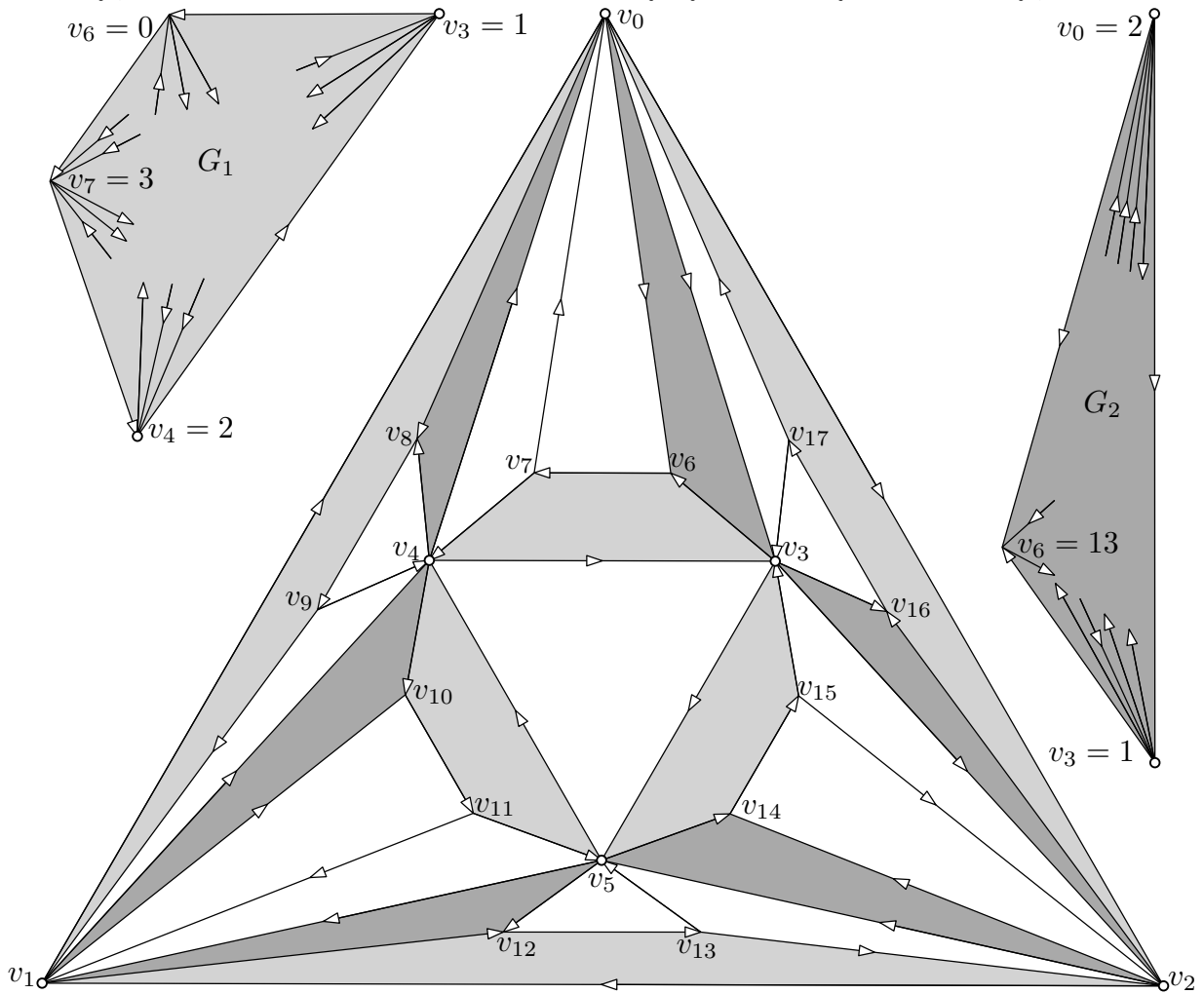

(c) A Eulerian oriented triangulation where the light (resp. dark) gray face is isomorphic to  $G_1$  (resp.  $G_2$ .)

Figure 16: The construction of the counterexample in Theorem 37.

*Proof of Corollary 12.* Take  $2k - 1$  copies  $G_1, \dots, G_{2k-1}$  copies of the graph  $G$  from Theorem 37 and identify the inner triangle  $v_5, v_4, v_3$  of  $G_i$  with the outer triangle  $v_0, v_1, v_2$  of  $G_{i+1}$  for  $1 \leq i \leq 2k - 2$ . The resulting graph  $H$  is a Eulerian oriented planar triangulation. Let  $I_1, I_2, I_3$  be its tripartition and suppose that  $\mathcal{A}$  is a connected acyclic

permeating subgraph such that  $|\mathcal{A} \cap I_1| < k$ . By the pigeonhole principle there is an  $1 \leq i \leq 2k - 1$  such that  $G_i \cap I_1 \cap \mathcal{A} = \emptyset$ . Since  $\mathcal{A}$  is connected then for any two vertices  $u, v \in \mathcal{A} \cap G_i$  there is a  $(u, v)$ -path  $P$ . If  $P$  leaves  $G_i$ , then  $P$  traverses one of the gluing triangles towards  $G_{i \pm 1}$  on two adjacent vertices of the triangles and can be shortened so it remains in  $G_i$ . Hence,  $\mathcal{A} \cap G_i$  is connected. But by Observation 8  $\mathcal{A}$  and  $\mathcal{I} = G_i - I_1 - \mathcal{A}$  are a CAI-partition of  $G_i - I_1$ , which by Theorem 37 implies that  $\mathcal{A} \cap G_i$  is disconnected. Contradiction.  $\square$

As a final remark of this section, we note that the underlying undirected graph of the construction obtained in Figure 16c is not a counterexample to Conjecture 2 (and thus is not a counterexample to Conjectures 4 and 3). To see this, let  $G_1, G_2$  be the underlying undirected graphs of  $G_1(0, 1, 2, 3), G_2(1, 2, 13)$  respectively. An easy case analysis shows that every partition into two forests  $A_1$  and  $A_2$  of vertices  $\{0, 1, 2, 3\}$  of  $G_1$ , can be extended to a partition into two forests  $A'_1 \supset A_1$  and  $A'_2 \supset A_2$  of  $G_1$ , such that in the subgraph induced by  $A_1$  in  $G_1 - \{(0, 1), (1, 2), (2, 3), (3, 0)\}$ , vertices of  $A_1$  (resp.  $A_2$ ) are not connected. A similar property can be shown for vertices  $\{1, 2, 13\}$  of  $G_2$ . With this in hand, it is enough to give a valid partition into two forests of the undirected subgraph of Figure 16c induced by vertices  $\{v_0, \dots, v_{17}\}$  and extend this partition to each of the light and dark faces.

## 7 Conclusion

Concerning Theorem 9, each of the graphs of Figure 15 has one less restriction and no CAI-partition as shown in Lemma 36. There is only one missing case that we leave as an open question:

**Question 39.** *Does every oriented bipartite or triangle-free 2-vertex-connected subcubic graph admit a CAI-partition?*

Furthermore, we believe that Theorem 10 can be generalized in the following way:

**Conjecture 40.** The vertices of a graph  $G$  of treewidth at most  $k$ , and connectivity at least  $k$  can be partitioned into an induced graph  $\mathcal{T}$  of treewidth at most  $k - 1$  and connectivity at least  $k - 1$  and an independent set  $\mathcal{I}$ .

Considering treewidth 0 graphs as independent sets, the case  $k = 1$  just says that trees are bipartite. Theorem 10 corresponds to  $k = 2$  since 2-vertex-connected simple series-parallel graphs are the 2-vertex-connected graphs of treewidth 2. Further, the conjecture holds for  $k$ -trees: just construct  $G, \mathcal{I}, \mathcal{T}$  along an elimination-ordering. Start with  $K_{k+1}, \{v\}, K_{k+1} - v$ , for any  $v \in K_{k+1}$ . If a new vertex  $u$  gets added and is adjacent to no element of  $\mathcal{I}$ , then add  $u$  to  $\mathcal{I}$  and add  $u$  to  $\mathcal{T}$  otherwise.

### Acknowledgments:

We thank František Kardoš for the initial discussion on the problems of this paper and for pointing out the result of Payan and Sakarovitch [30]. We further thank Marthe Bonamy for contributing to the proof of Theorem 9.

S.C. was supported by a FWO grant with grant number 1225224N and was supported during a research visit in 2021 by a Van Gogh grant, reference VGP.19/00015. K.K. was supported by the Spanish State Research Agency through grants RYC-2017-22701, PID2022-137283NB-C22 and the Severo Ochoa and María de Maeztu Program for Centers and Units of Excellence in R&D (CEX2020-001084-M). P.V. was partially supported by Agence Nationale de la Recherche (France) under research grant ANR DIGRAPHS ANR-19-CE48-0013-01. Moreover K.K. and P.V. were partially supported by Agence Nationale de la Recherche (France) under the JCJC program (ANR-21-CE48-0012).

## References

- [1] H. ALT, M. S. PAYNE, J. M. SCHMIDT, AND D. R. WOOD, *Thoughts on barnette's conjecture*, Australas. J Comb., 64 (2016), pp. 354–365.
- [2] B. BAGHERI GH., T. FEDER, H. FLEISCHNER, AND C. SUBI, *On finding Hamiltonian cycles in Barnette graphs*, Fundam. Inform., 188 (2022), pp. 1–14.
- [3] D. BARNETTE, *Conjecture 5*, in Recent Progress in Combinatorics: Proceedings of the Third Waterloo Conference on Combinatorics, W. T. Tutte, ed., Academic Press, New York, 1968.

- [4] H. L. BODLAENDER, *A partial  $k$ -arboretum of graphs with bounded treewidth*, Theoretical Computer Science, 209 (1998), pp. 1–45.
- [5] É. BONNET, D. CHAKRABORTY, AND J. DURON, *Cutting Barnette graphs perfectly is hard*, Theor. Comput. Sci., 1010 (2024), p. 15. Id/No 114701.
- [6] G. BRINKMANN, J. GOEDGEBEUR, AND B. D. MCKAY, *The minimality of the Georges-Kelmans graph*, Mathematics of Computation, 91 (2022), pp. 1483–1500.
- [7] G. L. CHIA AND S.-H. ONG, *On Barnette’s conjecture and CBP graphs with given numbers of Hamilton cycles*, in Proceedings of the third Asian mathematical conference 2000, University of the Philippines, Diliman, Philippines, October 23–27, 2000, Singapore: World Scientific, 2002, pp. 94–111.
- [8] M. L. L. DA CRUZ, R. S. F. BRAVO, R. A. OLIVEIRA, AND U. S. SOUZA, *Near-bipartiteness, connected near-bipartiteness, independent feedback vertex set and acyclic vertex cover on graphs having small dominating sets*, in Combinatorial Optimization and Applications, W. Wu and J. Guo, eds., Cham, 2024, Springer Nature Switzerland, pp. 82–93.
- [9] D. EPPSTEIN, *Parallel recognition of series-parallel graphs*, Information and Computation, 98 (1992), pp. 41–55.
- [10] J. FLOREK, *On Barnette’s conjecture*, Discrete Math., 310 (2010), pp. 1531–1535.
- [11] J. FLOREK, *On Barnette’s conjecture and the  $H^{+-}$  property*, J. Comb. Optim., 31 (2016), pp. 943–960.
- [12] J. FLOREK, *Graphs with multi-4-cycles and the Barnette’s conjecture*. Preprint, arXiv:2002.05288 [math.CO] (2020), 2020.
- [13] J. FLOREK, *Remarks on Barnette’s conjecture*, J. Comb. Optim., 39 (2020), pp. 149–155.
- [14] J. FLOREK, *A sufficient condition for cubic 3-connected plane bipartite graphs to be hamiltonian*, 2024.
- [15] J. HARANT, *A note on Barnette’s conjecture*, Discuss. Math., Graph Theory, 33 (2013), pp. 133–137.
- [16] W. HOCHSTÄTTLER, *A flow theory for the dichromatic number*, European Journal of Combinatorics, 66 (2017), pp. 160–167.
- [17] D. HOLTON, B. MANVEL, AND B. MCKAY, *Hamiltonian cycles in cubic 3-connected bipartite planar graphs*, Journal of Combinatorial Theory, Series B, 38 (1985), pp. 279–297.
- [18] J. D. HORTON, *On two-factors of bipartite regular graphs*, Discrete Mathematics, 41 (1982), pp. 35–41.
- [19] F. Kardoš, *A computer-assisted proof of the Barnette–Goodey Conjecture: Not only fullerene graphs are hamiltonian*, SIAM Journal on Discrete Mathematics, 34 (2020), pp. 62–100.
- [20] K.-I. KAWARABAYASHI AND C. THOMASSEN, *Decomposing a planar graph of girth 5 into an independent set and a forest*, J. Comb. Theory, Ser. B, 99 (2009), pp. 674–684.
- [21] S. KHULLER, *Ear decompositions*, abstract, SIGACT News 20, 128, 1989.
- [22] K. KNAUER, C. RAMBAUD, AND T. UECKERDT, *Partitioning a planar graph into two triangle-forests*, arXiv:2401.15394, (2024).
- [23] K. KNAUER AND P. VALICOV, *Cuts in matchings of 3-connected cubic graphs*, European Journal of Combinatorics, 76 (2019), pp. 27–36.
- [24] Z. LI AND B. MOHAR, *Planar digraphs of digirth four are 2-colorable*, SIAM Journal on Discrete Mathematics, 31 (2017), pp. 2201–2205.
- [25] X. LU, *A note on Barnette’s conjecture*, Discrete Math., 311 (2011), pp. 2711–2715.
- [26] B. MOHAR AND C. THOMASSEN, *Graphs on surfaces*, Baltimore, MD: Johns Hopkins University Press, 2001.
- [27] R. NEDELA, M. SEIFRTOVÁ, AND M. ŠKOVIERA, *Decycling cubic graphs*, Discrete Mathematics, 347 (2024), p. 114039.
- [28] R. NEDELA AND M. ŠKOVIERA, *Cyclic connectivity, edge-elimination, and the twisted isaacs graphs*, Journal of Combinatorial Theory, Series B, 155 (2022), pp. 17–44.

- [29] V. NEUMANN-LARA, *Vertex colourings in digraphs. some problems*, technical report, University of Waterloo, July 8 1985.
- [30] C. PAYAN AND M. SAKAROVITCH, *Ensembles cycliquement stables et graphes cubiques*, Cah. centr. et. rech. operat. (Colloq. theor. graphes, Paris, 1974), 17 (1975), pp. 319–343.
- [31] A. RASPAUD AND W. WANG, *On the vertex-arboricity of planar graphs*, Eur. J. Comb., 29 (2008), pp. 1064–1075.
- [32] R. STEINER, *Neumann-Lara-flows and the two-colour-conjecture*, master’s thesis, FernUniversität in Hagen, Fakultät für Mathematik und Informatik, 2018.
- [33] P. G. TAIT, *Listing’s topologie*, Philosophical Magazine, 17 (1884), pp. 30–46. Reprinted in Scientific Papers, Vol. II, pp. 85–98.
- [34] C. THOMASSEN, *Decomposing a planar graph into an independent set and a 3-degenerate graph*, J. Comb. Theory, Ser. B, 83 (2001), pp. 262–271.
- [35] W. T. TUTTE, *On Hamiltonian circuits*, Journal of the London Mathematical Society, s1-21 (1946), pp. 98–101.
- [36] W. T. TUTTE, *On the 2-factors of bicubic graphs*, Discrete Mathematics, 1 (1971), pp. 203–208.
- [37] H. WHITNEY, *Non-separable and planar graphs*, Transactions of the American Mathematical Society, 34 (1932), pp. 339–362.